



REVGROUP

Smart Reach™ Aerial Ladder
57 - 77 - 102 - 107 - 127 Foot Reach

CAT. RML-SR-057-127-2304
April 2023

SMART REACH™ AERIAL LADDER OPERATIONS & SERVICE MANUAL



Spartan Fire, LLC.

Operation and Service Manual

All information and specifications contained in this manual are based on the latest information available at the time of printing and are subject to change. Illustrations in this manual are intended for reference use only.

Spartan Fire, LLC reserves the right to discontinue or change specifications or design at any time without prior notice and without incurring any obligation whatsoever.

Brand names may be used in this manual to clarify illustrations or descriptions.

Spartan Fire, LLC
1541 Reynolds Road
Charlotte, MI 48813

800-867-6478

www.emergencyresponse.spartanmotors.com

COPYRIGHT 2023

Using this document

This document is expected to be used as an electronic pdf document as well as a printed document. Various software can be used to view the document, including [Adobe® Acrobat Reader DC](#). Other pdf viewers are available.

As an electronic document, various links are included to help you navigate the document and find the applicable information. Links may be cross references within the document or an external link to an Internet page. Links shown in blue, underlined text, such as the link to the Acrobat Reader DC software in the preceding paragraph. For an Internet link to work, the device must be connected to the Internet in some way. Data charges may apply.

NOTE: Most pdf viewer software provides a command for previous view. In Acrobat Reader, for instance, the previous view on the View/Page Navigation menu. Keyboard shortcuts are also available, such as Alt+Left Arrow and Alt+Right Arrow for Previous View and Next View, respectively.

INTRODUCTION	1.1
Service Support	1.1
Emissions Warranty	1.1
Obtaining Customer Service	1.1
Reporting an Accident	1.1
Safety Defect Reporting	1.1
GENERAL SAFETY	2.1
Introduction.....	2.1
Operator Manuals.....	2.1
Major Component Manuals.....	2.1
Industry Standards and Guidelines.....	2.1
Apparatus Modifications	2.2
Extrication and Air Bags.....	2.2
To the Apparatus Driver/Operator	2.2
To the Apparatus Mechanic.....	2.3
To the Safety Officer.....	2.3
To the Training Officer.....	2.4
To the Fire Chief.....	2.4
Parades and Public Events	2.4
Not Designed for Children.....	2.4
Vehicle Data Recorder.....	2.5
Safety Alerts.....	2.5
Safety Alert Symbol	2.5
Signal Words.....	2.5
Follow a Safety Program.....	2.6
Always Be Alert.....	2.6
Be Careful.....	2.6
Know the Rules	2.6
Commercial Driver’s License Course.....	2.6
Practice Safe Practices	2.7
Safety Signs.....	2.7
Operate Only What You Know.....	2.7
Operate Only Well Inspected Apparatus.....	2.7
General Hazard Identification.....	2.7
Jewelry and Loose Personal Items.....	2.8
Pinch and Crush Hazards.....	2.8
Rotating Parts Hazards.....	2.8
Exhaust Fumes.....	2.9
Fire	2.10
Electrical Shock	2.10
Noise	2.11
Undercarriage.....	2.12

TABLE OF CONTENTS

Custom Chassis Safety.....	2.12
Understand Your Operating Environment	2.12
Know Your Response Area.....	2.12
Know Your Climate.....	2.13
Know the Rules of the Road	2.13
Traffic Signal Capturing	2.13
Securing Equipment.....	2.13
Secure Interior Equipment.....	2.13
Secure Exterior Equipment.....	2.14
Restrain Hose.....	2.14
Working on Top of your Apparatus.....	2.15
Avoid Climbing and Walking on Top.....	2.15
Clean From the Ground	2.15
Use Three Points of Contact.....	2.15
Clean and Repair	2.16
Slip Resistant Surfaces	2.16
Designated Stepping, Standing and Walking Surfaces	2.16
Folding Steps or Ladders.....	2.17
Open Compartment Doors.....	2.17
Working on Top of the Apparatus.....	2.17
Climbing Prohibitions.....	2.18
Working Around the Apparatus.....	2.18
Ride Safely	2.18
Cab Capacity.....	2.18
Seat Belts.....	2.18
Seat Back Position	2.19
Shoulder Belt Positioning	2.19
Safest Posture.....	2.19
Seatbelt Sliding Komfort Latch®.....	2.20
Transporting Children	2.20
Seats Without Seat Belts.....	2.20
Swivel Seats.....	2.20
Air Bags	2.21
Helmets.....	2.21
SCBA Storage	2.22
SCBA Pack Buckles and Receivers.....	2.22
Drive Safely.....	2.23
Controls Adjustment	2.23
Driver Seat Adjustment	2.23
Mirror Adjustment	2.23
Visibility Check.....	2.23
Seat Belt Monitoring.....	2.24
Know Your Tire Limitations.....	2.24
FEMA Fire Tanker Guidelines	2.24

TABLE OF CONTENTS

Liquid Loads and High Center of Gravity.....	2.24
Driving on Rough Roads	2.25
Driving Off-Road	2.25
No-Spin Axle Differential.....	2.26
Tire Chains.....	2.26
Water Fording.....	2.26
Heater Shut-Off Valve.....	2.27
Stop Safely.....	2.27
Brake System Pressure	2.27
Anti-Lock Brake Systems.....	2.27
Maintaining Control	2.27
New Brake Lining Performance.....	2.27
Quick Build-Up Air Brake Pressure System	2.27
Auxiliary Braking Systems.....	2.28
Descending Steep Grades.....	2.28
Electronic Stability Control.....	2.28
Parking Brakes and Wheel Chocks	2.29
Auxiliary Front Wheel Lock.....	2.29
Backing Your Apparatus	2.29
Parking Safely.....	2.30
Parking On a Grade	2.30
Park Away From Fire.....	2.30
Leaving Apparatus Unattended	2.31
Park Away From Power Lines	2.31
Idle Mitigation.....	2.32
Winch and Rope Anchors	2.32
Fuel Safely.....	2.33
Before Placing your Apparatus In-Service.....	2.33
Install Electronic Equipment Properly.....	2.33
Install Front Bumper Mounted Equipment Properly.....	2.34
Install Cab Interior Equipment Properly	2.34
Install Air Pressure Operated Equipment Properly	2.34
Consider Dissimilar Metals When Mounting Equipment.....	2.35
Load your Apparatus Properly	2.35
Establish Correct Tire Pressure Values.....	2.35
Leaf Spring Suspensions With U-Bolts.....	2.35
Safety Equipment.....	2.35
Demonstration and Training	2.36
Pumper Safety.....	2.36
Storing, Deploying and Retrieving Hose Safely.....	2.36
Snags and Snarls.....	2.36
Slips and Falls.....	2.36
Driving while Deploying	2.37
Driving while Retrieving.....	2.37

TABLE OF CONTENTS

Hose Bed Covers	2.37
Using Hose Safely	2.38
Hose on the Fire Scene	2.38
Testing Hose	2.38
Discharge Water Safely.....	2.38
Water Stream.....	2.38
Power Lines and Fire Suppression.....	2.38
Boiling Discharge Water	2.38
Matching Equipment to Pump Pressure.....	2.39
Pump Operation	2.39
Emergency Pump Procedures With Failed Engine Control.....	2.39
Pressure Fluctuations	2.39
Intake and Discharge Caps	2.40
Pump and Roll	2.40
High Pressure Two-Stage Pump	2.41
Ultra-High Pressure Water Stream	2.41
Ultra-High Pressure Piercing Equipment.....	2.41
Foam Concentrate Types.....	2.42
Water Monitor	2.42
Ground Water Monitor	2.42
Aerial Safety.....	2.42
Emergency Stop Feature.....	2.43
Emergency Power Unit	2.43
Over-Ride Controls.....	2.43
Interlocks.....	2.43
Prepare for Safe Aerial Operation.....	2.44
Select a Site	2.44
Set-Up	2.45
Setting Up Within Safe Limits.....	2.45
Short-Jacking	2.46
Operating Your Aerial Safely	2.47
Primary Control Operator	2.47
Secondary Control Operator.....	2.48
Use of a Spotter	2.48
Avoid Overhead Power Lines	2.48
Extra Precautions Around Power Lines.....	2.49
If Your Device Becomes Electrified.....	2.49
Rungs Aligned	2.49
Fall Protection.....	2.49
Climbing the Aerial Ladder.....	2.50
Water Towers.....	2.51
Boom Style Platform.....	2.51
Wire Rope Hazard	2.51
Operating With Personnel on the Aerial Ladder	2.52

TABLE OF CONTENTS

Ladder Base Pinch and Crush.....	2.53
Operating with Personnel Near the Aerial	2.53
Operating Within Safe Limits.....	2.53
Load Chart Limits and People on the Ladder	2.54
Approaching Structures	2.54
Operating Above Structures	2.55
Icing Conditions	2.55
Windy Conditions	2.55
Flying Flags	2.56
Lightning Threat.....	2.56
Rope Rescue	2.56
Pre-Piped Waterway and Monitor	2.57
Waterway Monitor.....	2.58
Aerial Ladder Pipe Operation	2.58
Tractor Drawn Aerial Operations.....	2.58
Tiller Cab Safety.....	2.58
Tiller Steering Lock.....	2.58
Tiller Steering.....	2.59
Tractor Operator Training.....	2.59
Tiller Operator Training.....	2.59
Fifth Wheel Lock.....	2.59
Perform Maintenance Safely.....	2.59
Maintenance Records.....	2.59
Use OEM Parts for Repair.....	2.59
Running the Engine	2.61
Preparing for Maintenance.....	2.61
Compressed Air for Cleaning - DO NOT USE.....	2.61
Chemicals and Cleaners.....	2.61
Decontamination Chemicals	2.61
Tilting the Cab.....	2.62
Lock-Out Tag-Out.....	2.63
Access Features Not Provided	2.63
Confined Space	2.63
Welding.....	2.63
Interlocks.....	2.64
Batteries	2.64
Battery Charging	2.64
High Pressure Hydraulic Fluid.....	2.65
Aerial Device Equipment Mounting	2.65
Aerial Device Inspection.....	2.65
Radiator Cap.....	2.66
Seat Belt Inspection and Replacement.....	2.66
Side Roll or Frontal Crash Occupant Protection.....	2.67
Suspension Seat Tethers.....	2.68

TABLE OF CONTENTS

Tire Inflation Pressure	2.68
Tire Wear Inspection.....	2.68
Tire Replacement.....	2.68
Manual Parking Brake Release (Caging the Brakes).....	2.69
Line-Voltage Components and Wiring	2.69
Shoreline Electrical Connection.....	2.69
Wire Rope Inspection or Maintenance	2.70
Air Conditioning Refrigerant.....	2.70
Towing Your Apparatus	2.70
No-Spin or Locking Differentials.....	2.70
CONTROL DESCRIPTIONS.....	3.1
Overview.....	3.1
Major Component Description	3.1
Aerial Related Controls in the Cab.....	3.2
Stabilizer Controls.....	3.3
Stabilizer Control Panel.....	3.3
Stabilizer Controls.....	3.5
Aerial Ladder Controls	3.7
Primary Operator Control Station.....	3.7
Smart Reach Aerial Display.....	3.10
Controls at the Tip of the Ladder	3.13
Other Controls & Systems	3.14
Aerial Waterway	3.15
OPERATING PROCEDURES	4.1
Overview.....	4.1
Understanding Multi-Stance™	4.1
Multi-Stance Variable Ladder Loading	4.1
Static Load Charts.....	4.3
Level Indicators.....	4.4
Angle, Height, and Reach Chart	4.4
NFPA 1901 Aerial Device Ratings	4.4
Operational Requirements.....	4.4
Aerial Device Loading	4.4
Operational Restrictions	4.5
Preparing the Apparatus for Ladder Operations.....	4.7
Pre-Operation Readiness.....	4.7
Selecting a Set-up Site	4.7
Provide Aerial Power.....	4.8
Engaging the Fire Service Pump after the PTO is in Operation	4.8
Engaging PTO after the Fire Service Pump is in Operation.....	4.8
Automatic High Idle Function	4.9
Wheel Chock Positioning.....	4.9

TABLE OF CONTENTS

Stabilizing the Apparatus.....	4.9
Stabilizer Pads	4.9
Stabilizer Beam Extension.....	4.9
Leveling Apparatus Equipped with Four Stabilizers	4.10
Leveling Apparatus Equipped with Rear Stabilizers Only	4.11
Short-Set Operation.....	4.12
Ladder Operations.....	4.13
Preparing for Ladder Operation.....	4.13
Basic Operations.....	4.14
Rotating the Ladder into a Reduced Capacity Zone	4.16
Alley Jack Procedure	4.16
Stowing the Aerial Ladder	4.16
Stowing the Ladder.....	4.16
Stowing the Stabilizers.....	4.17
Ladder Optional Features.....	4.18
Pre-Piped Waterway and Monitor	4.18
Positional Waterway.....	4.20
Aerial Standpipe Connection	4.21
Secondary Operation from the Ladder Tip Control - Optional.....	4.22
Wireless Remote Control Monitor Operations - Optional.....	4.23
Rope Rescue System	4.23
Breathing Air System.....	4.25
Breathing Air Operation	4.25
Rescue and Firefighting Equipment Stored on Ladder.....	4.26
Ergonomic Hose Load (EHL)	4.26
To Stow the EHL	4.27
Operation of Safety Interlock Overrides and Backup Systems	4.27
Rotation Limiting for Stabilizer Short Set.....	4.28
Ladder/Stabilizer Interlock.....	4.28
Bed Zone/Body Collision System Interlock.....	4.29
Emergency Power Unit (EPU)	4.30
Manual Overrides.....	4.31
SERVICE PROCEDURES	5.1
Introduction.....	5.1
Routine Inspections	5.1
Daily checks of the Aerial Device	5.1
Weekly Inspection of the Aerial Device	5.2
Lubrication and Preventive Maintenance	5.3
Hour Meters.....	5.3
Lubricants	5.3
Special Lubrication Recommendations	5.3
Lubrication Chart	5.4

TABLE OF CONTENTS

Lubrication and Preventive Maintenance Schedule	5.4
Ten and Fifty Hour Lubrication Schedule.....	5.5
Ten-Hour Preventive Maintenance Inspection Schedule.....	5.6
Fifty-Hour Lubrication Schedule	5.8
Fifty-Hour Preventive Maintenance, Inspection, & Testing Schedule.....	5.8
Non-Destructive Testing.....	5.11
Aerial Annual Inspection Criteria.....	5.13
Rotation Bearing Mounting Bolts.....	5.13
Rotation Gear Backlash.....	5.13
Structural Fasteners	5.15
Relief Hydraulic Pressure.....	5.16
Hydraulic Cylinder Allowable Drift	5.16
APPENDIX	6.1
Graphical Symbol Definitions.....	6.1

LIST OF FIGURES

Figure 2-1.	Level indication of 6 degrees.....	2.45
Figure 2-2.	Short Set Rotation Interlock Stop Points.....	2.47
Figure 3-1.	Major Component Descriptions.....	3.1
Figure 3-2.	Cab Controls.....	3.2
Figure 3-3.	Stabilizer Control Panel.....	3.3
Figure 3-4.	Stabilizer Information Screen.....	3.3
Figure 3-5.	Hydraulic System Information Screen.....	3.4
Figure 3-6.	Engine Information Screen.....	3.5
Figure 3-7.	Stabilizer Controls - 4 Beams and 4 Jacks.....	3.5
Figure 3-8.	Auto Level Actuation Button.....	3.6
Figure 3-9.	Primary Operator Control Station.....	3.7
Figure 3-10.	Incline Meter.....	3.9
Figure 3-11.	Extension Indicator Marks.....	3.9
Figure 3-12.	Smart Reach Multi-Stance™ Load Chart Screen.....	3.10
Figure 3-13.	Advanced Rung Lighting Menu Screen.....	3.11
Figure 3-14.	Aerial Controls Trouble Shooting Menu.....	3.12
Figure 3-15.	Hydraulic I/O Screen.....	3.12
Figure 3-16.	Aerial Maintenance Screen.....	3.13
Figure 3-17.	Ladder Tip Controls.....	3.13
Figure 3-18.	Monitor and Nozzle Control.....	3.14
Figure 3-19.	Ladder Movement Stops Prior to Contacting Body of Apparatus.....	3.14
Figure 3-20.	Breathing Air System High-Pressure Cylinder.....	3.15
Figure 3-21.	Breathing Air System Gauges.....	3.15
Figure 3-22.	Waterway Controls - Electronic and Manual Valve.....	3.16
Figure 3-23.	Waterway Drain and Aerial Inlet.....	3.16
Figure 4-1.	Stabilize Beam - Tip Load Zone Indicators.....	4.1
Figure 4-2.	Aerial Screen.....	4.2
Figure 4-3.	Static Load Chart Storage and Mounting Locations.....	4.3
Figure 4-4.	750 lb. (340.2 kg) Static Load Charts.....	4.3
Figure 4-5.	500 lb. (226.8 kg) Static Load Charts.....	4.6
Figure 4-6.	250 lb. (113.4 kg) Static Load Charts.....	4.6
Figure 4-7.	Wheel Chocks.....	4.9
Figure 4-8.	Leveling an Apparatus with 4 Stabilizers.....	4.10
Figure 4-9.	Leveling an Apparatus with 2 Stabilizers.....	4.12
Figure 4-10.	Aerial Operation Motions.....	4.14
Figure 4-11.	Maintain Sufficient Ladder Clearance.....	4.15
Figure 4-12.	Entering Reduced Capacity Zone Message.....	4.16
Figure 4-13.	Nozzle Motion - Standard Range.....	4.18
Figure 4-14.	Nozzle Motion - Extended Range.....	4.19
Figure 4-15.	Monitor at the end of the Fly Section.....	4.20
Figure 4-16.	Monitor at the end of Next Lower Ladder Section.....	4.20
Figure 4-17.	Positional Waterway Controls and Lock.....	4.21

LIST OF FIGURES

Figure 4-18. Aerial Standpipe Connection.....	4.21
Figure 4-19. Change of Direction Bar in Stowed Position	4.23
Figure 4-20. Change of Direction Bar in Mounting Brackets.....	4.23
Figure 4-21. Center Locking Pin	4.24
Figure 4-22. Locking Pin Handle in Locked Position.....	4.24
Figure 4-23. EHL Location.....	4.26
Figure 4-24. Crash Hazard.....	4.27
Figure 4-25. Interlocks Disabled Message.....	4.28
Figure 4-26. Diverter Valve Block.....	4.32
Figure 4-27. Aerial Ladder Manual Overrides	4.33
Figure 4-28. Stabilizer Valve Bank and Override Levers	4.33
Figure 5-1. Lubrication Chart.....	5.4

Table 2-1: NIOSH Recommended Noise Limits.....	2.11
Table 2-2: Working Zone.....	2.46
Table 2-3: Beaufort Scale (For Reference Only).....	2.55
Table 5-1: Recommended High-Temperature Grease.....	5.3
Table 5-2: Recommended Multi-Purpose Grease.....	5.4
Table 5-3: Lubrication Service Points.....	5.5
Table 5-4: Rotation Bearing Mounting Bolts.....	5.13
Table 5-5: Rotation Bearing Clearance.....	5.14
Table 5-6: Structural Fasteners.....	5.15
Table 5-7: Hydraulic Cylinder Allowable Drift.....	5.16
Table 5-8: Aerial Device Deployment.....	5.16
Table 5-9: Performance Values.....	5.16

For future use

INTRODUCTION

SERVICE SUPPORT

Emissions Warranty

In conformance with 40CFR§1037.120 this apparatus is warranted to the ultimate purchaser and each subsequent purchaser that the tires delivered with this new vehicle will be free from defects in materials and workmanship that cause the vehicle to fail to conform to the requirements of 40CFR§1037 Control of Emissions from New Heavy- Duty Motor Vehicles for 2 years or 24,000 miles.

Engine emissions related items will be free from defects in materials and workmanship that cause the vehicle to fail to conform to the requirements this standard for 5 years or 100,000 miles.

Obtaining Customer Service

Most questions regarding operation or service should be addressed to your apparatus dealer organization. If you are unable to obtain satisfactory assistance, or if your questions remain unanswered, please contact customer service at:

Spartan Fire, LLC

1541 Reynolds Road

Charlotte, MI 48813

880 867 6478

E-mail: www.emergencyresponse.spartanmotors.com

Reporting an Accident

Notify Spartan Fire, LLC., any time your apparatus is involved in an accident resulting in personal injury or death. The company will investigate all such incidents. Never remove, damage, or modify any part of your apparatus that is involved in an accident investigation.

Customer Service must be notified whenever the Side Roll Protection System or Frontal Occupant Protection System has been activated. DO NOT remove or tamper with any Side Roll Protection System or Frontal Occupant Protection System components, except to extricate the occupants.

Safety Defect Reporting

If you believe that your vehicle has a defect which could cause a crash or could cause injury or death, you should immediately inform the National Highway Traffic Safety Administration (NHTSA) in addition to notifying Spartan Fire, LLC.

If NHTSA receives similar complaints, it may open an investigation, and if it finds that a safety defect exists in a group of vehicles, it may order a recall and remedy campaign. However, NHTSA cannot become involved in individual problems between you, your dealer, or Spartan Fire, LLC.

To contact NHTSA, you may call the Vehicle Safety Hotline toll-free at 1-888-327-4236 (TTY: 1-800-424-9153); go to <http://www.safercar.gov>; or write to: Administrator, NHTSA, 400 Seventh Street, SW., Washington, DC 20590. You can also obtain other information about motor vehicle safety from <http://www.safercar.gov>.

INTRODUCTION

To contact EPA, address concerns to:

Director Field Operations and Support Division
Environmental Protection Agency
401 M St. SW., Washington, DC 20460

GENERAL SAFETY

INTRODUCTION

Operator Manuals

This operation and service manual is one in a set of manuals that instructs you on how to properly and safely operate an apparatus. For a complete understanding of the safe and proper operation of your apparatus you must read, study, understand, and follow the information found in each of the manuals provided to you.

These may include the following:

- Custom Chassis.
- Commercial Chassis.
- Aerial Device.
- Pumping System.

These manuals do not replace, nor does their use absolve you from complying with any and all applicable Federal, State, or Provincial regulations, safety codes, operating limitations, fire company procedures or insurance requirements.

Major Component Manuals

Additional safety, operation, and service information is located in the associated major component operation and service manuals. Study the safety information found in all the manuals provided including manuals for the engine, transmission, pump, breathing air system, foam system, generator, and others included in the information provided with the delivery of your apparatus.

Industry Standards and Guidelines.

There are many industry standards and guides that you and your department must follow to safely operate your apparatus including those shown here.

- **NFPA® 1911** *Standard for the Inspection, Maintenance, Testing, and Retirement of In-Service Emergency Vehicles*
- **NFPA® 1451** *Standard for a Fire and Emergency Service Vehicle Operations Training Program*
- **NFPA® 1500** *Standard on Fire Department Occupational Safety, Health, and Wellness Program*
- **NFPA® 1962** *Standard for the Inspection, Care, and Use of Fire Hose, Couplings, and Nozzles and the Service Testing of Fire Hose*
- **IFSTA** *Pumping and Aerial Apparatus Driver/Operator Handbook*
- **FAMA** *Fire Apparatus Safety Guide* (additional copies available from FAMA.org)
- **FEMA** *Safe Operation of Fire Tankers* (downloadable from FEMA.org)
- **PSHSA** *Electrical Safety Handbook for Emergency Responders* (Public Services Health and Safety Association of Canada, www.pshsa.ca)

SAFETY

Apparatus Modifications

Modification of this apparatus from its original design without written permission from the manufacturer is strictly prohibited and may result in subjecting personnel to a risk of injury or death. The manufacturer reserves the right to change, improve, modify or expand features of its products at any time, without notice, and without incurring any obligations to change, improve, modify or expand features of previously delivered equipment.

EXTRICATION AND AIR BAGS

Your apparatus may be equipped with occupant roll-over or front crash protection airbags and other pyrotechnic devices that may deploy during a rollover or frontal crash.

In case it is necessary to perform the extrication of an occupant of this vehicle, performing any one of the following will disable the roll or frontal sensors and any unfired protective devices:

- Turn battery master switch to the OFF position, OR
- Move ignition switch to the OFF position, OR
- Disconnect the batteries, OR
- Cut the wires to the protective device actuators.

Fired protective devices pose no toxic threat to rescue personnel. After a side roll accident, the seat belts on all the occupants will be tight, but have specially designed buckles that can be released under belt tension. Use extreme care when releasing seat belt buckles and exiting a damaged vehicle. The bags will be filled with warm inert gases. The gases will be nearly invisible, but will have an acrid smell. The gases pose no harm to occupants or rescue personnel.

TO THE APPARATUS DRIVER/OPERATOR

A custom fire apparatus is not a consumer product; it is a complex piece of industrial equipment. It has the potential to harm you or those around you if you use it improperly. Safe operation requires you to be trained, be experienced, be smart and use your common sense. It is essential that you be careful, physically and mentally qualified, trained in the safe operation of this equipment, and authorized by your fire department to do so.

Never work on or around a fire apparatus, or operate it, unless you have:

- Read and understood this operation and service manual.
- Watched and understood any safety video(s).
- Read and understood any other operation and service manuals associated with your apparatus.
- Read and understood the operation manual(s) of components supplied with this apparatus.
- Read and understood the FAMA Fire Apparatus Safety Guide.
- Read and understood all safety signs posted on your apparatus.
- Been trained in the safe operation of this apparatus in accordance with NFPA 1451 Standard for a Fire and Emergency Service.

- Been properly trained and are authorized to operate your apparatus.

If you do not feel comfortable with your knowledge, training, level of experience or the adequacy of your personal protective equipment, stop what you are doing and report this to your supervisor. If you feel that the apparatus is not functioning safely, stop what you are doing, report it to your fire department safety officer or fire chief, and do not use the apparatus until the hazardous situation can be resolved.

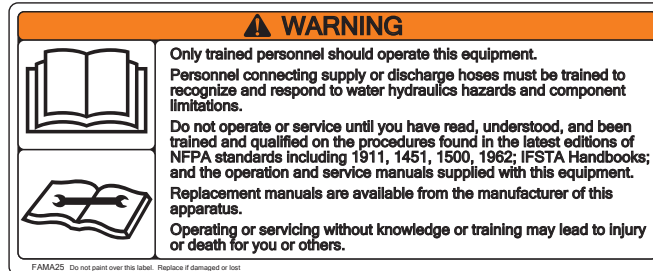

TO THE APPARATUS MECHANIC

Fire apparatus are complex machines made of thousands of parts. As with all machines, they must be constantly maintained and can break down. The safety of the firefighters using your apparatus, as well as the safety of people in your community, depend on frequent and thorough inspection, service and maintenance of your apparatus and its associated equipment. Since you will probably need to operate your apparatus in the course of servicing it, you must be intimately familiar with safe methods of operation as well as safe maintenance practices.

If you do not feel comfortable with your knowledge, training, level of experience or adequacy of your personal protective equipment, stop what you are doing and report this to your supervisor. If you feel that the apparatus is not functioning safely, stop what you are doing, report it to your fire department safety officer or fire chief, and do not use the apparatus until the hazardous situation can be resolved.

Never attempt to service or maintain a fire apparatus unless you have:

- Read and understood the FAMA Fire Apparatus Safety Guide.
- Watched and understood any applicable safety video(s).
- Read and understood this operation and maintenance manual(s).
- Read and understood the operation and maintenance manual(s) of components supplied with your apparatus.
- Been properly trained and are authorized to maintain and operate your apparatus.

TO THE SAFETY OFFICER

NFPA 1521 *Standard for Fire Department Safety Officer* establishes specific and essential responsibilities for your role relating to the safe operation of fire apparatus in your department. You are expected to participate in the specification of new apparatus to ensure that the apparatus will include safe features consistent with the way your department will operate. You are also expected to monitor your apparatus while it is being used to make sure that the firefighters using your apparatus are doing so in a safe manner.

SAFETY

The highly custom nature of fire apparatus makes your role and responsibilities extremely important. Fire department operations vary greatly and we cannot anticipate all the potential ways your apparatus may be used. It is your responsibility to make sure the ways your department operates are consistent with the instructions in this manual. Where a custom feature is not covered, it is your responsibility to make sure safe practices are established and followed. It is essential that you anticipate the way your department personnel will use your apparatus and how it is actually being used once it is placed in service. A custom feature, or a common feature installed in an uncommon fashion, may present a hazard that was not apparent at the time of manufacture. If you observe anything that you feel is unsafe, it is your responsibility as established by NFPA 1521 to address it. Contact us if you need help and we will work with you to ensure that your apparatus is safe in every regard.

TO THE TRAINING OFFICER

NFPA 1451 *Standard for a Fire and Emergency Service Vehicle Operations Training Program* establishes specific and essential responsibilities for training in the safe operation of fire apparatus in your department. Personnel must never be allowed to operate an apparatus unless you are convinced that they have been thoroughly trained in its safe operation, and they are experienced enough to operate safely all the time without supervision. They must be trained to operate safely all the time, not cut corners, not operate the apparatus in ways it was not intended, and not be careless with the safety of themselves or others. NFPA 1451, Annex B offers a detailed checklist of potential hazards found on apparatus that every operator must be trained to avoid.

TO THE FIRE CHIEF

As with any piece of complex industrial equipment, your apparatus is designed to be operated only by trained, experienced and sophisticated users. Many fire chiefs have had to deal with tragic outcomes when apparatus have been placed in the hands of poorly trained, inexperienced or undisciplined personnel. Such mistakes can result in injury or death to firefighters, the victims you are intending to rescue or innocent bystanders. It is essential that you support your safety and training officers, foster a culture that promotes safe operation and provide consequences for those who choose not to follow the rules.

Parades and Public Events

Your apparatus is designed for personnel to be transported only while wearing seatbelts. Transporting people who are not seated and belted should never be allowed. Before using your apparatus in parades, educational demonstrations, charitable fundraisers, or other community events where untrained people will be in, on, or around your apparatus you must create a safety plan that will protect them from harm. Before allowing anyone other than a trained and experienced member of your department near your apparatus, you should consult with your fire department safety officer and plan for safety. Be sure to follow all the safety procedures in this manual, and ensure that the event will be conducted in a manner that is safe for everyone involved.

Not Designed for Children

Your apparatus is designed for adult fire fighters and is not suitable for the transportation of children. Your apparatus is compliant to the Federal Motor Vehicle Safety Standards that apply to trucks over 10,000 lbs. These standards expect that operators are adult professions and they do not account for the needs of children. Features including the following may not be appropriate for accommodating children or people of extremely small stature.

- SCBA Seating.

- Seat Belt Accommodations.
- Inflatable Occupant Restraints.
- Power Window Controls.
- Child Seat Attachments.

Vehicle Data Recorder

Your NFPA 1901 compliant apparatus includes a Vehicle Data Recorder (VDR). This device allows you to download data from your apparatus that will tell you certain safe driving information such as whether your apparatus is driving too fast, stopping too quickly, or being operated with unbelted occupants. The intention of this device is to assist you in monitoring, training, and enforcing safe apparatus driving practices. Download and use this data regularly to ensure that the personnel under your supervision are operating safely.

SAFETY ALERTS

The safety signs found on your apparatus and in this manual use the ANSI Z535 safety alert symbol system. You should be familiar with this system and understand the meaning of each symbol.

Safety Alert Symbol

The Safety Alert Symbol means: "ATTENTION! STAY ALERT! YOUR SAFETY IS INVOLVED!".



The Safety Alert Symbol identifies important safety messages on your apparatus, on your equipment, on safety signs, in manuals or elsewhere. When you see this symbol, be alert to the possibility of death or personal injury. Follow instructions in the safety message.

Signal Words

Signal words are intended to alert you of a potential hazard, the general severity of the hazard and that a message will follow which will provide instruction on how to avoid the hazard.

 **DANGER**

Danger: Indicates a hazardous situation which, if not avoided, **WILL** result in death or serious injury.

 **WARNING**

Warning: Indicates a hazardous situation which, if not avoided, **MAY** result in death or serious injury.

CAUTION

Caution: (without safety alert symbol) Indicates a situation which, if not avoided may cause equipment damage.

FOLLOW A SAFETY PROGRAM

Turnout gear is important any time you are operating on or around your apparatus. Your fire apparatus is heavy equipment, and PPE is appropriate any time you are using it.

You may need:

- Boots.
- Helmet.
- Heavy-duty gloves.
- Reflective clothing.
- Hearing protection.
- Safety glasses, goggles or face shield.

Always Be Alert

As a first responder you are trained to be situationally aware. This means you are always looking out for what is around you even in the midst of an emergency. This awareness is just as important during mop-up, training, testing, cleaning, service, maintenance or any other time you are working in, on or around your apparatus. Don't be tempted to forget the importance of being aware and alert when there is no emergency. Many injuries occur during routine operations when your guard is down. You may be tempted to relax around the apparatus when performing tasks you have done many times before. Avoid this temptation. Your equipment must be respected at all times for your safety and the safety of those around you.

Be Careful

Mistakes are more likely when you are tired, distracted, or overwhelmed. Call in extra assistance and let someone else take over if you become fatigued or ill. Never operate on or around your apparatus under the influence of drugs or alcohol. Operating your apparatus in an un-well condition can lead to death or injury for you or others.

Know the Rules

Your department will have rules and procedures to keep you safe. These must include the instructions in this manual. Know the rules and follow them. If you find a conflict in the rules work with your department's safety officer to resolve the conflict.

Commercial Driver's License Course

Your state may exempt you as a firefighter from the requirement to hold a commercial driver's license (CDL), but the rig you are driving may be bigger and heavier than most other trucks on the road. Commercial drivers must learn the right way to inspect and operate heavy trucks and demonstrate their abilities before they are issued a license. Consider taking these courses and obtaining your CDL even if not

required to do so by your department. You will learn valuable safety tips, demonstrate your skills and feel more confident behind the wheel of your apparatus.

Practice Safe Practices

It is not enough to simply be instructed on safe apparatus operation. Consistently safe operation happens because you know how to operate safely and have practiced safe operation long enough to establish safe habits that are committed to both your mental memory and your muscle memory. Never cut corners in safety during practice sessions to avoid unintentionally cutting corners during an emergency.

Safety Signs

Read and understand all the safety signs on your apparatus before you operate the equipment. They communicate the most critical safety messages, but they are meant to remind only. You should know, memorize, and follow the instructions without needing to read them during operation.

Operate Only What You Know

Your apparatus may have unique characteristics or features that were custom ordered by your department. Other apparatus in your fleet may have different unique characteristics or features. Only operate an apparatus that you are completely familiar with and that you have been trained and authorized to use safely.

Operate Only Well Inspected Apparatus

Your apparatus must be in excellent working order at all times if you are going to ensure your own safety and the safety of others.

Follow the NFPA 1911 Standard for the Inspection, Maintenance, Testing and Retirement of In-Service Automotive Fire Apparatus and your manufacturer's operation and service manuals to keep your apparatus safe for operation. These publications will tell you what to check, what to test, how often they need to be checked or tested, and when you should remove your apparatus from service.

Your apparatus should be inspected thoroughly on a regular basis. Study the inspection criteria found in this manual, the other applicable operator manuals, the decals and markings on the apparatus itself, and your State's commercial driver's license pre-trip inspection requirements. Determine how each requirement will apply to your apparatus and consolidate this data into a single pre-trip or start-of-shift inspection. Determine when and by whom the inspections will be performed, make sure these individuals are trained and qualified to perform the inspections, and establish a regular inspection schedule. Make sure you perform each inspection in teams of two, with one person operating interior controls while the second person is checking for exterior functions such as turn signal lamps, flashers, brake lights, etc.

Record all deficiencies in compliance with NFPA 1911 Standard for the Inspection, Maintenance, Testing and Retirement of In-Service Automotive Fire Apparatus. Review the previous inspection report at the start of each shift to ensure that any deficiency that was noted by the previous crew has been resolved.

GENERAL HAZARD IDENTIFICATION

Your apparatus will have safety signs warning of the more common hazards, but not every hazard will be identified with a safety sign. You must use your common sense. Look for and avoid these general hazards. Study your apparatus to identify each hazard and develop methods of avoiding each. It is best to make this a written plan so that you can share it with all the personnel who may be working on or around your apparatus.

SAFETY

Jewelry and Loose Personal Items

Loose fitting clothing, long hair, dangling jewelry and rings may catch on the apparatus or be pulled into moving equipment. Personnel working on or servicing fire apparatus should avoid wearing loose fitting clothing, long hair, dangling jewelry and rings which may catch on the apparatus or be pulled into moving equipment. Wear gloves, safety glasses and other PPE that protects you from the potential hazards of the task you are performing.

Pinch and Crush Hazards

Look for places where there are moving parts such as folding steps, aerial ladders, rollout shelves, aerial turntables, stabilizers, cab and compartment doors, etc.

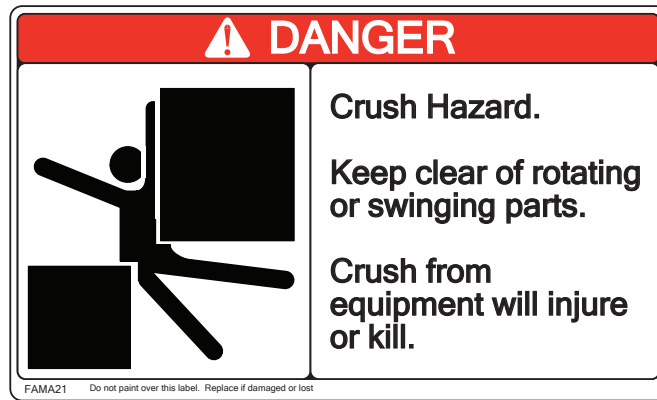

Rotating Parts Hazards

Common rotating parts include; drive shafts, power take-off shafts, cooling fans, compressors, generators and hose or cord reel drives. Do not wear loose clothing or other items that could get tangled in the shafts or fans. Many rotating parts can begin to spin without warning; therefore, treat each hazard as if it were spinning already.

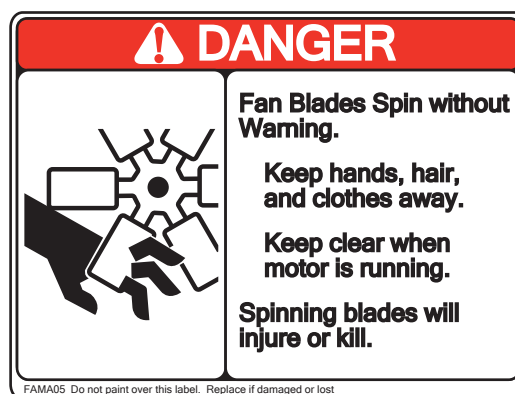

Hot Parts Hazards

Common hot parts include; engine, exhaust, air compressors, water pumps, air conditioning compressors, foam pumps, line voltage generators, and fuel-fired heaters.

Diesel engines equipped with diesel particulate filters require regeneration that involves high heat. The exhaust system can get extremely hot without warning. Keep away from exhaust gas and do not park your apparatus where the exhaust pipe points toward or near flammable material.



Exhaust Fumes

Internal combustion engines give off hazardous fumes while running. Never run your apparatus engine inside a building unless the exhaust discharge is connected to an extraction system. Diesel engine exhaust and some of its constituents are known to the State of California to cause cancer, birth defects and other reproductive harm. Do not operate any internal combustion engine in an area where exhaust gases can accumulate or serious injury or death may occur. If exhaust fumes are suspected of entering the vehicle cab, rectify the defect immediately. Do not perform a DPF regeneration inside a building. Do not stay inside your parked apparatus cab for extended periods of time with the engine running as exhaust fumes could seep into the cab causing illness or death.

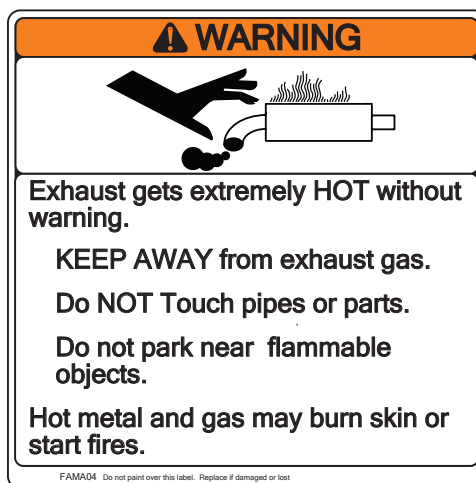

SAFETY

Chemical Exposure

Your apparatus could expose you to chemicals that the State of California has determined can cause cancer. Avoid exposure to these chemicals including Diesel Exhaust, Gasoline Exhaust, and Gasoline Vapors. Check with the California website to learn more at <https://oehha.ca.gov/proposition-65/chemicals>.

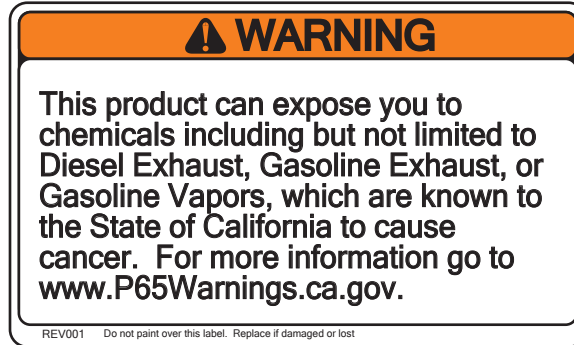

Fire

Your apparatus is composed of many parts that can catch on fire. These include fuel, oils, plastics, rubber, vinyl and cloth. It also has a source of ignition in the form of batteries and electrical wiring. Chaffed wires can cause heat or sparks that can start a fire. Avoid parking your apparatus, or any other motor vehicle, inside any structure that has common walls with a sleeping area. Install fire alarms and sprinklers in garage bays. Make sure that your apparatus is well maintained and that hot components and wire harnesses are kept free of grease, oils and other contaminants. Clean all build-up of oily or greasy dirt that can burn and spread a vehicle fire quickly.

If your apparatus catches on fire while driving:

- Bring vehicle to a complete stop as quickly as possible.
- Apply parking brake.
- Shut down engine.
- Turn off master power switch.
- Leave vehicle.

Electrical Shock

Your apparatus may be equipped with line voltage capability (120 V, 240 V, etc.). Common sources of line voltage include invertors, gas or diesel generators, generators driven by power-take-off shafts from the main engine, or hydraulically powered generators. You will also have line voltage on board while you have your apparatus plugged in to shore power.

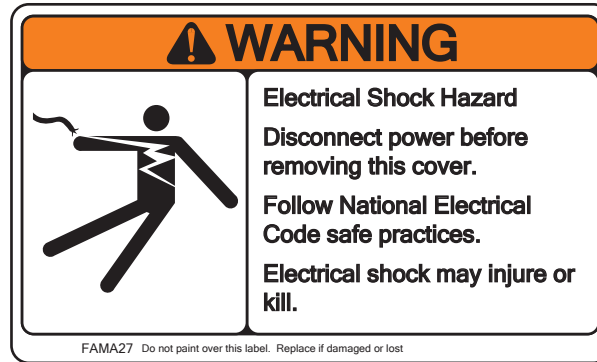

Noise

Your apparatus may be equipped with audible warning devices that create loud noise to clear traffic. There may be local and state laws in your area governing the use of such devices. Use the city horn instead of the air horns and sirens unless needed.

Sirens produce loud sounds that may damage hearing:

- Roll-up windows.
- Wear hearing protection.
- Use only for emergency response.
- Avoid exposure to siren sound.

Do not operate sirens or air horns with personnel standing in the immediate vicinity (within 50 feet) of the front of your apparatus.

Always use hearing protection such as ear plugs, muffs, or noise canceling intercom headsets to keep your noise exposure within the following NIOSH recommended limits.

Table 2-1: NIOSH Recommended Noise Limits

Duration Exposure per day (Hours)	TWA A-weighted SPL (db)
8	85
4	88
2	91
1	94
1/2	97
1/4	100
1/8 (7 min. 30 sec.)	103
1/16 (3 min. 45 sec.)	106
1/32 (1 min. 53 sec.)	109

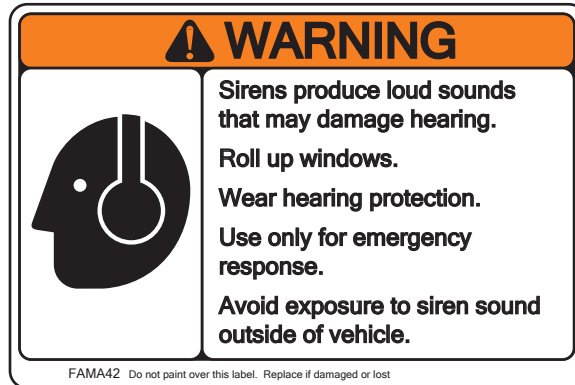

Establish a departmental hearing conservation program to monitor the hearing levels of fire department personnel in accordance with the guidelines found in *NFPA 1500 Standard on Fire Department Occupational Safety, Health and Wellness Program*.

Your apparatus is equipped with noise suppression components as part of the engine emissions system and powertrain. Do not remove or disable noise suppression components for any purpose other than maintenance, repair, or replacement.

Undercarriage

Use special caution if you need to be underneath your apparatus for any reason. The bottom of your apparatus is not designed to be an operational area, and there are many hazards you will encounter including rotating drivelines, PTO shafts, hot exhaust, pumps, and components which may emit hot steam or chemicals. Inform others and use lock-out tag-out procedures before working beneath your apparatus.

CUSTOM CHASSIS SAFETY

Understand Your Operating Environment

Know Your Response Area

Your apparatus is higher, heavier, longer, and wider than many other vehicles on the road. State and Federal regulations allow fire apparatus to have higher axle weights than other commercial vehicles. These factors mean that you need to be more careful than other vehicles about where you can safely operate.

Drive your streets in your apparatus and plan your routes around the size, weight, and capability of your apparatus.

NOTICE

Any areas where your apparatus should not be driven. Plan response routes to cover your district while avoiding these hazards.

Pay special attention to the following:

- Road weight limits.
- Bridge weight limits.

- Low overhead wires.
- Low trestles, bridges, and under-passes.
- Low traffic signals.
- Railroad crossings.
- Cul de sacs, dead ends, and turn-arounds.
- Narrow roads and alleyways.
- Narrow roads with steep drop-offs or soft shoulders.

Know Your Climate

Like any other machine, fire apparatus may require special consideration in inclement weather. High winds, freezing rain, flooding, snow, ice, as well as extreme heat or cold, can all present special challenges to safe operation. Think about the types of extreme weather common to your area and make a list of the special hazards these may present. You will find many weather related precautions throughout this manual. Identify special procedures to counter extreme conditions and practice them while in good weather so that you know what to do when nature turns against you.

Know the Rules of the Road

Your local laws may allow you more road privileges than the general public, but they do not change the laws of physics. You must know the limitations of your apparatus, respect these limitations and drive defensively at all times. Your apparatus is a heavy vehicle that will take more time to accelerate, more distance to stop and is less stable in turns than your passenger vehicle. Heavy axle weights will make it more likely that if you wander onto a soft shoulder you will be drawn off the road and into a ditch. Always drive your apparatus safely and deliberately. The few extra minutes you save running the red light or driving fast through the curves will be lost if you don't arrive safely.

Check the operation of your lights and sirens prior to the start of each shift. Do not rely on your audible and visual warnings to clear the right of way. People may not hear, see or heed your warning signal. You must recognize this fact and continue driving cautiously.

Traffic Signal Capturing

Your apparatus may include a system that works with your local traffic control signals to increase the potential that you will always get a green light at a controlled intersection. While such systems are useful to improve your response time, they are not foolproof. Like any mechanical or electrical system they are susceptible to failure. It is also possible that your apparatus gets pre-empted by another emergency vehicle with a higher priority. You should, therefore, never assume that you will get a green light. Always obey traffic signals.

SECURING EQUIPMENT

Secure Interior Equipment

If your apparatus crashes it will stop quickly, but items inside the cab will keep going at the speed the apparatus was traveling prior to the crash. Only store items in a cab that can be secured in compartments or in strong brackets. The compartment or bracket should be able to hold the item even if you pull on it with a force equal to nine times its weight.



Secure Exterior Equipment

Ground ladders or other equipment that falls off your apparatus can injure or kill drivers or pedestrians in your path. Make sure that every compartment door is closed and secured and every piece of equipment is locked in its bracket before you drive away. Inspect compartment door hardware and equipment brackets regularly to make sure your equipment stays on the apparatus where it belongs.

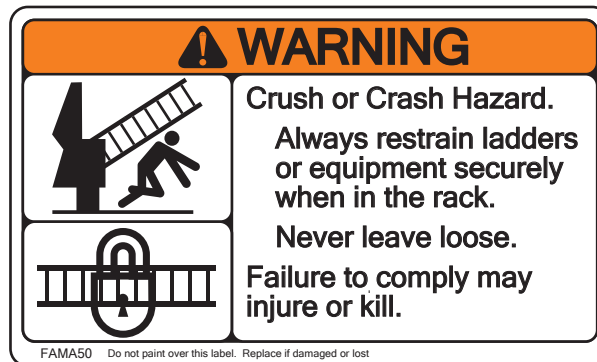

Restrain Hose

Your apparatus includes a hose restraining method for all your designated hose storage areas. Hose that falls off your apparatus can injure or kill drivers or pedestrians in your path. Never drive your apparatus without the hose restraints securely in place.



WORKING ON TOP OF YOUR APPARATUS

Slips, trips and falls are one of the most common ways of being injured when working around your apparatus.

Avoid Climbing and Walking on Top

Avoid the need to climb on your apparatus by locating items you need to access during emergency operations in compartments that can be reached from the ground. Store equipment above ground level only that you can access in the station or other controlled environment where you can use safety ladders, lifts, or use fall protection equipment to retrieve them.

Clean From the Ground

Perform routine windshield, cab glass, and mirror surfaces from the ground using brushes and squeegees mounted on extension poles. When better access is necessary for washing the entire apparatus use platforms, safety ladders or other means to avoid climbing on wet slippery surfaces.

Use Three Points of Contact

Three points of contact means you have one hand and two feet, or two hands and one foot in contact with the vehicle at all times. If you can't find sturdy features to provide three points of contact, have the vehicle modified or repaired. When climbing, it is very difficult to maintain three points of contact without facing the vehicle. Always face your apparatus when getting on and off. Backing out is much safer.



SAFETY

Clean and Repair

Keep steps, walking surfaces, hand rails and shoes free of grease, mud, dirt, fuel, ice and snow. Inspect your apparatus steps, walking surfaces, and handrails frequently. If defects are found remove the apparatus from service until repairs can be made.

Slip Resistant Surfaces

The NFPA standards specify the performance that slip resistant surfaces must meet. Only step or walk on surfaces that are slip resistant. If you must walk or work on a surface that is not slip resistant, do so only in a controlled environment using fall protection equipment. In addition to fall restraint devices, use rubber mats or other means to keep you from slipping.

Designated Stepping, Standing and Walking Surfaces

If your apparatus was contracted for after January 1, 2016, it will have designated standing or walking surfaces at any location above 48 inches from the ground where you may need to access during normal operation.

You can tell which surfaces are designated for standing or walking as follows:

- The surface will have a slip resistant surface. (Except for hose storage areas). AND...
- The surface will have a yellow or orange line surrounding it. OR...
- The surface will have railings or structure at least 12.0 in. (304.8 mm) high surrounding it.

Do not stand or walk on any feature of your apparatus that is over 48.0 in. (1,219.2 mm) above the ground unless it meets these criteria. Any surface over 48.0 in. (1,219.2 mm) high that does not meet these criteria must only be accessed using service ladders and a fall protection system or other safe means as determined by your fire department safety management personnel.

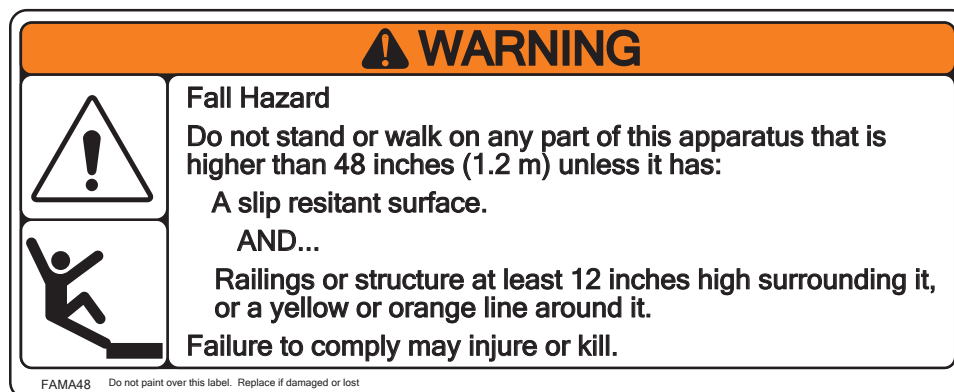

Some surfaces, such as diamond plate or tread plate may be used in construction of features that are not intended to be walked on. It may be used for aesthetic appeal, or to protect painted surfaces from wear. Just because a surface is constructed of diamond plate or tread plate does not mean that it is designated to be walked or stepped upon.



Folding Steps or Ladders

Certain steps or ladders may be of a pivoting or folding design. They may deploy automatically, or they may need to be deployed by hand. In either case, make sure they are firmly engaged in the weight bearing position before using them. Also make sure they are stowed again before placing the vehicle in motion.



Open Compartment Doors

When climbing or walking on the vehicle, never step on a horizontally hinged cover or compartment door that has been left open. Hold-open devices are not designed to support more than the weight of the door itself. Also, never step on the edge of a vertically hinged door that has been left open. In either case the doors will move and you are likely to fall.

Working on Top of the Apparatus

For those times when working on the top of your apparatus is unavoidable, you must use extra precaution from the moment you leave the ground.

- Stay away from the edge.
- Always use three points of contact.
- Only step on surfaces that are slip resistant.
- Never step on open, horizontal compartment doors.
- Never step on open, vertical compartment door edges.

SAFETY

Climbing Prohibitions

Do not step or climb upon any vehicle surface unless it is slip resistant and handholds are provided. Never climb using features on your apparatus such as lights, sirens, inlet or outlet valves, controls, compartment doors, or other non-climbing features.

Working Around the Apparatus

Open compartment doors that extend out from the vehicle may create a head-strike hazard to others working in the area. Take the time to close compartment doors after you have retrieved your equipment. This goes the same for other items that hang off the apparatus such as deployable ladder racks, slide-out shelves, hose trays, portable tank racks, etc. If you are working at night, be sure to light up the area to reduce the risk of running into things.

- Use scene lights during night operation.
- Always wear your fire helmet when working around your apparatus.
- Keep compartment doors, trays and equipment racks closed or stowed when not in use.

RIDE SAFELY

Cab Capacity

Your apparatus cab is designed to carry a maximum number of occupants while it is in motion. Never place the apparatus in motion with more than the maximum number as designated on the label in the cab and never without every occupant seated and belted.

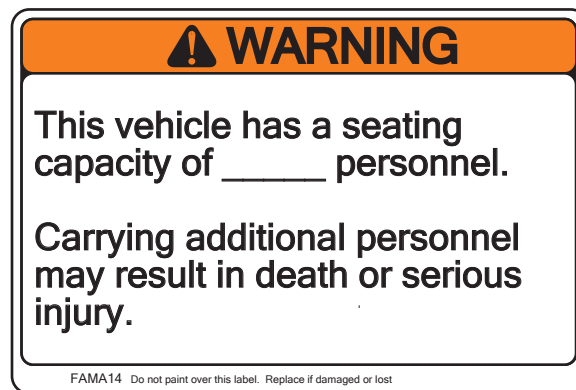

Seat Belts

Wearing your seat belt is the single most important thing you can do to keep yourself safe while riding in a fire apparatus. Put your gear on before you ride or plan to put it on after you arrive on the scene. Follow these rules to minimize your risk of injury during a crash:

- Always wear a seat belt when the vehicle is in motion.
- Ride with the seat back upright and your lap belt snug and low about the hips.
- Keep your shoulder belt snug against your chest.
- Never wear your shoulder belt under your arm or swing it around your neck over the inside shoulder.

- Never use a single belt for more than one person or one seating position.
- Place your seat belt inside the cab before closing the door.
- Have your belts replaced if they are damaged or worn.



Seat Back Position

Do not drive or ride with your seat back reclined. Your seatbelt may not function properly in a crash if the seat is reclined.

Shoulder Belt Positioning

If your seat belt is equipped with a height adjuster, use it to move the shoulder belt into the proper position as shown.

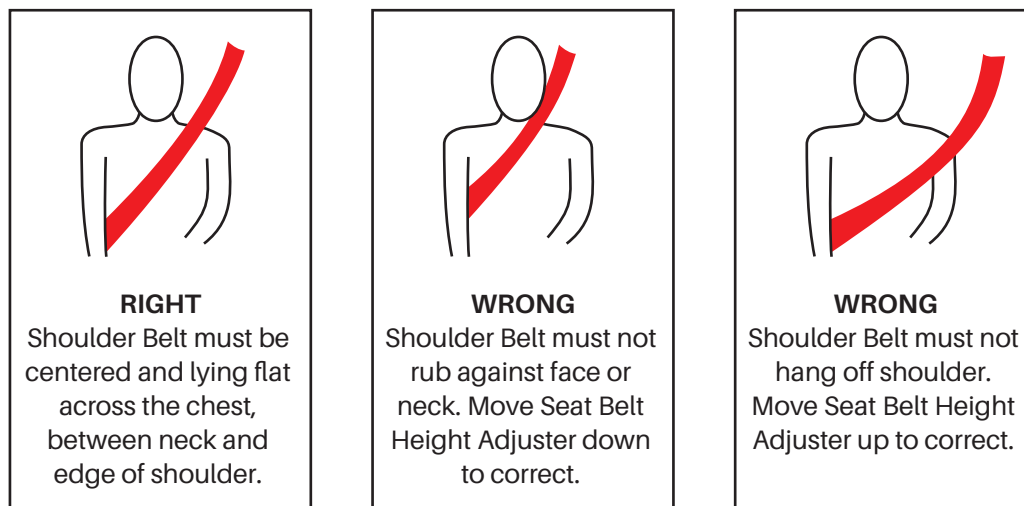

Safest Posture

Seat belts provide the best restraint when:

- Seat back is upright.
- Occupant is sitting upright; not slouched.
- Lap belt is snug and low on the hips.

SAFETY

- Shoulder belt is snug against the chest.
- Knees are straight forward.

Seatbelt Sliding Komfort Latch®

Your apparatus seat belts may be equipped with the Sliding Komfort Latch[®] that allows you to introduce a small amount of slack in the belt to relieve pressure on your chest while driving.

- Do not introduce more than 1.0 in. (25.4 mm) of slack when using the Sliding Komfort Latch[®].
- Using the seat belt with too much slack can reduce its effectiveness during a crash.
- Always disengage the Sliding Komfort Latch[®] when removing the seat belt to allow the seat belt to fully retract.

Transporting Children

Your apparatus occupant protection systems are designed to accommodate adult firefighters who may be wearing protective gear. It is not designed for transporting children. Do not transport children in your apparatus, they should be transported in appropriate passenger vehicles only.

Seats Without Seat Belts

Your apparatus may be equipped with work areas that include seats without seat belts. These seats are meant to be used only when the apparatus is stopped with the parking brake applied and the wheels properly chocked. If the seats are in an area of the apparatus that is occupied during driving, make sure they are either bolted down or otherwise secured so that they do not become a projectile in a crash.

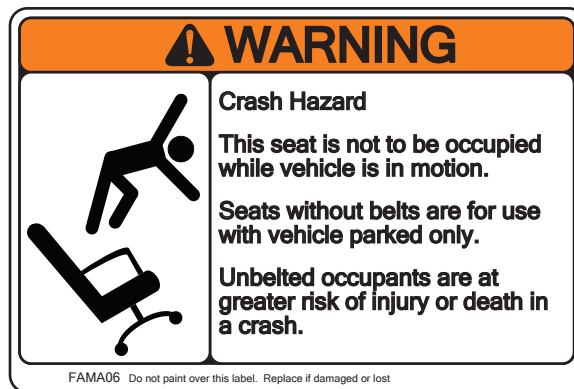

Swivel Seats

Your apparatus may be equipped with a seat that can be swiveled. The seat may be provided with multiple locking positions. Select the proper seating orientation before the vehicle is placed in motion and ensure that it is thoroughly engaged in the locked condition.

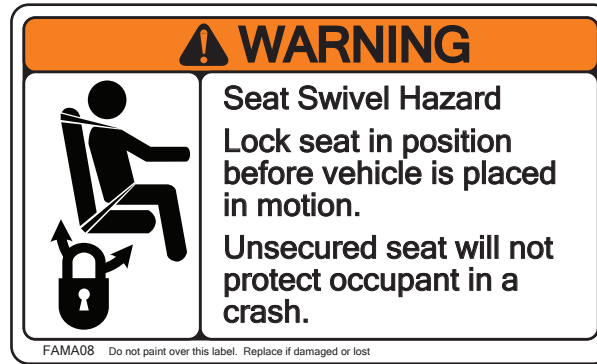

Air Bags

Your apparatus may be equipped with inflatable occupant restraints (air bags) that inflate if the apparatus rolls onto its side. Your apparatus may also be equipped with inflatable occupant restraints that inflate during a frontal crash. These air bags will only be effective in helping to protect you in a crash if you are also wearing your seat belt. Your seatbelt and associated safety devices will position you to allow the air bags to be effective in a crash.

If your apparatus is equipped with both air bags and suspension style seats, then the system will include a device for pulling the suspension seat down to its lowest position prior to the air bag inflating. This will happen in a split second.

If your apparatus is equipped with air bags, you must learn where they are, where they will deploy and what other devices will deploy in a crash.

Always follow these rules:

- Learn where each air bag on the vehicle will deploy.
- Do not place objects in the path of an air bag deployment.
- Do not cover seats with clothing or other items that will interfere with air bag deployment.
- Keep items and body parts away from the path of the suspension seat mechanism and seat belt tensioning devices.

Failure to follow these precautions may increase the risk of death or injury in a crash.

Helmets

Fire helmets are designed for a specific purpose and are not intended to provide protection in a crash. Wear your fire helmets when working around your apparatus, but do not wear it when your apparatus is in motion. Use approved helmet holders or other means of restraining your helmet in the event of a crash.



SCBA Storage

Your apparatus may be equipped with SCBA storage in the seat backs. Some SCBA storage devices must be adjusted to the specific SCBA bottle size or SCBA pack make or model. Make sure the bracket is adjusted properly and that any straps, buckles or latches are fully engaged so that the pack will not come loose during a crash. Leave your pack straps off or keep them loose while sitting in the seat as the bracket is not designed to take the weight of both you and your pack during a crash.

Before placing your apparatus in motion:

- Ensure SCBA bottles and packs are properly secured.
- Use seat back insert in seats where SCBA pack is not being stored.
- If wearing the SCBA harness, make sure it is loose.
- Place movable headrests in the closed position.
- Adjust SCBA holders for the SCBA pack make, model, and size.

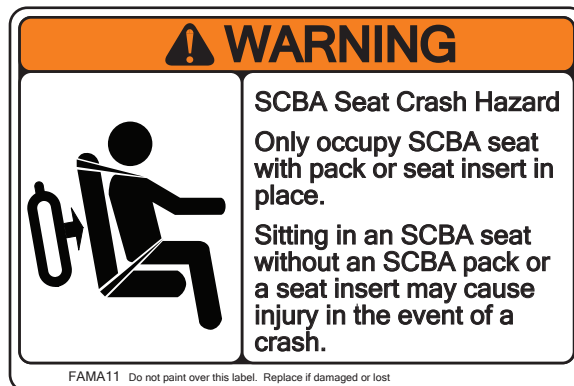

SCBA Pack Buckles and Receivers

Your SCBA pack harnesses may be equipped with buckles and receivers that are similar to the buckles and receivers of your seat belts. Take care to ensure that you do not mistake one for the other. You will not be protected during a crash if the seat belt buckle is inserted into your SCBA pack receiver or vice versa.

DRIVE SAFELY

Controls Adjustment

It is important to keep your driving related controls properly adjusted for the person who will be driving. Make your adjustments at the start of your shift, and never make adjustment while driving. If you must readjust while driving, pull over when it is safe, stop the vehicle, place the transmission in neutral, apply the parking brake, and then make adjustments safely.

Adjust all controls prior to driving including the following:

- Steering wheel.
- Driver seat.
- Mirrors.
- Seat belt.
- Sun visor.

Driver Seat Adjustment

Adjust your driver seat at the start of your shift. Do not adjust seats with apparatus in motion. To obtain best ride quality, adjust suspension seats to the center of their vertical travel. Ensure proper reach to steering wheel and pedals.

Mirror Adjustment

Adjust seat before adjusting mirrors. Adjust your mirrors at the start of your shift. Adjust mirrors in a way that will optimize visibility to the sides and the rear. Using a partner, have them walk around the sides and the rear of the vehicle to determine where the blind spots are. Make sure any exterior view cameras are pointed properly and that their lenses are clean and unobstructed.

- Know your blind spots.
- Adjust seats and mirrors at the start of every shift or before driving.

Visibility Check

Ensure that you have excellent visibility using the following checklist:

- Windshield glass is clean.
- Cab side glass is clean.
- Mirrors are clean.
- Rear, side, or birds-eye cameras are clean and functioning.
- Windshield wipers function and blades are in a condition to wipe thoroughly.
- Washer fluid reservoir is full with commercial non-freezing washer fluid and washer sprayer is functioning.

SAFETY

Seat Belt Monitoring

Your apparatus includes a seat belt monitoring system that will alert you when an occupant is sitting in a seat but has not buckled their seat belt. Always check this monitor and do not release the parking brake until all occupants are seated and belted.

Know Your Tire Limitations

Fire apparatus axle weights are often higher than typical heavy trucks. Tire manufacturers recognize the need for fire apparatus to carry higher loads and that in most cases a fire apparatus does not travel at high speeds for long periods of time. Tire manufacturers will rate some of their tires with a special “fire service” intermittent duty rating. This allows the tire to carry greater loads or attain higher speeds as long as it does not have to do so for extended periods of time. To avoid tire degradation, fire service rated tires have limits on the amount of time they can be driven at high speed and high load before they must be allowed to cool down. Study your tire ratings, compare them to your in-service tire loads and know the speeds you can operate and any cool down periods that may be required.



FEMA Fire Tanker Guidelines

The US Fire Administration’s “Safe Operation of Fire Tankers” report is available as a pamphlet from FEMA, or it is available as a download from their website. Read this report completely, learn about the precautions and techniques it describes, and practice driving your fire tanker or tender safely. This report can be downloaded from the FEMA website at www.usfa.fema.gov.

Liquid Loads and High Center of Gravity

If your apparatus includes water, foam or other fluid tanks, you must take special precautions while driving. Liquid surge results from the movement of liquid in a partially full tank. There are two common times when liquid surge becomes a problem. The first is when you change directions, such as when negotiating a curve in the road. If you enter the curve too fast, centrifugal force will cause the liquid to surge against the wall of the tank and push your apparatus away from the turn. In severe situations, this surge can be sufficient to push you off the roadway or cause you to rollover.

Liquid surges will also affect your apparatus when stopping. During braking, the liquid surges toward the front of the tank. This additional force surging forward can further increase the stopping distance of your apparatus. After you come to a stop, the liquid in the tank will continue to slosh back and forth. On slippery road surfaces, this could cause your apparatus to be pushed forward into a hazard such as an intersection or a railroad crossing.

Whenever possible, do not drive with partial water loads. Keep the water tank full or empty when driving.

In addition to the hazard of a liquid load, your apparatus has a higher center of gravity (CG) than a passenger vehicle. A high CG makes your apparatus more likely to roll over in a turn. Never exceed the posted cautionary speed limit.

These combinations of factors mean that you need to slow down and be extra careful when making maneuvers such as:

- Lane changes.
- Curves at highway speeds.
- Tight radius turns.
- Downgrades leading into ramps.
- Curves on roads without a bank.
- Tight radius exits and off-ramps.
- Driving on any road with a cautionary speed limit posted.

Driving on Rough Roads

Your apparatus is primarily designed to operate on smooth paved surfaces. Driving on un-paved or poorly maintained roads will require you to slow down and proceed with caution. Your seating systems may not compensate for severe road conditions leading to injury. Slow down and use caution prior to encountering severe road conditions such as:

- Potholes, ruts or sinkholes.
- Speed bumps.
- Railroad crossings.
- Road construction.

Driving Off-Road

When you leave the public roads you must take extra precautions to ensure the safety of yourself, your vehicle, and those around you. It is likely that your apparatus has higher axle weights than typical off-road capable trucks and will be more susceptible to sinking into soft soil. A fluid load and higher center of gravity also require additional caution.

Know the capability of your apparatus and follow these guidelines:

- Always drive straight up or down a hill; never drive sideways on a hill.
- Get out and look. Walk the terrain before proceeding into unknown conditions.
- Check off-road conditions in your response area ahead of time so that you will know what to expect.
- Stay clear of excavations that are not properly shored up. Stay as far away from an excavation as it is deep (One to one ratio rule).
- Look for off-road hazards such as marshy areas, buried culverts, private bridges, animal dens, or other features that may not support your weight.

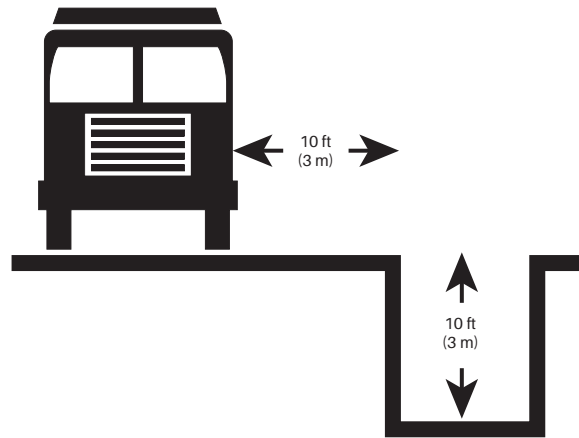

One-to-One Ratio Stay-Away Rule

No-Spin Axle Differential

Your apparatus may be equipped with a No-Spin differential or differential lock. With this feature engaged, use extreme caution when accelerating or decelerating on slippery or unstable surfaces. Vehicles equipped with traction or locking differentials are inherently more sensitive to side-slip.

Operate in low gear when coasting downhill into a turn. Braking capacity is reduced when a No-Spin or locking differential equipped vehicle makes a turn while coasting downhill.

Tire Chains

Never install tire chains on the steer tires. Installation of tire chains on the front tires may cause extensive damage to the cab as well as safety critical parts of the steering and brake systems. Damage to these components may lead to serious injury or death.

Water Fording

Your apparatus is not designed for operation in deep water. Your apparatus is capable of fording fresh stationary water at a depth not to exceed the center of the tire at slow speeds and for short distances only. Forging deeper water, at faster speeds, and for longer distances, can damage apparatus components leading to equipment failure, loss of apparatus capability, and expensive repairs. Never drive into flowing water like flash floods, rivers, creeks or streams. Flowing water has tremendous power and can sweep your apparatus away.

Components that will be affected by high water operation include:

- **Engine air intake** – Water in the air intake will cause the engine to stop and may cause extensive damage.
- **Drive Axles** – Breathers on the top side of drive axle housings can ingest water causing axle gear damage.
- **Engine Fan** – Operating in high water can cause fan blade damage.
- **Electronics** – Connectors, wiring, electronic modules, can be damaged or shorted out by submersion.
- **Batteries** – Submersion of the apparatus batteries will kill the batteries and stall the engine.

Operation in salt water will cause damaging corrosion and lead to equipment failure.

Always know the depth of water before proceeding.

Heater Shut-Off Valve

Your apparatus may be equipped with a heater shut-off valve. This valve may have been specified by your department to ensure that there is no hot coolant supplied to the cab heater core during hot seasons of the year. Use this valve with caution and make sure it is open whenever needed. Use of the heater shut-off valve will prevent warm air from circulating through the defroster system and may lead to a reduced ability to clear humidity from the windshield and subsequent reduced driver visibility.

STOP SAFELY

Brake System Pressure

Your apparatus braking system relies on air pressure created by a pump that runs off the apparatus engine. Do not release the parking brake and move the vehicle until the front and rear air gauges indicate at least 60 psi in both circuits. 100 psi is preferred for maximum stopping capability.

Anti-Lock Brake Systems

Your apparatus is equipped with an anti-lock braking system (ABS). ABS monitors the rotation of the wheels and pulses the brakes when it senses a skid. This can help you maintain control during a stop. ABS can greatly increase the control you have when stopping on wet or slippery surfaces, but it cannot provide more braking performance than the road conditions will permit. Your apparatus is big and heavy and should always be operated with caution knowing that it takes a lot of energy to bring it to a stop.

Maintaining Control

- Do not pump brakes on vehicles equipped with ABS. Anti-lock type brakes pulsate to prevent lock-up. Pumping brakes defeats the anti-lock function.
- Hold the steering wheel with both hands on opposite sides of the wheel.
- Always look 12 to 15 seconds ahead of where you are driving.
- Ensure adequate distance between the vehicle you are driving and the vehicle ahead. Braking distances can double when the vehicle is loaded.

New Brake Lining Performance

If your apparatus has had its brake linings replaced, they will need to be broken in before they will perform as well as the old linings did. Brake linings need to be "burnished" after installation. This is the process of wearing the high spots off the linings so that they grab over their entire surface. Be alert to any service work on your apparatus involving brake lining replacement and adjust your driving accordingly. The vehicle's stopping distance and the capability of the vehicle to hold on a specific grade may decrease temporarily whenever new brake lining material is installed.

Quick Build-Up Air Brake Pressure System

Your apparatus may include a quick build-up air brake feature as required by NFPA 1901 Standard for Automotive Fire Apparatus. The quick build-up feature allows the vehicle to be driven even though the front air brake reservoir may not have sufficient air pressure to enable sustained or full force braking.

SAFETY

While this is a requirement of the NFPA standard, it is not recommended ever beginning to drive your apparatus without the air reservoirs fully charged. If you chose to make use of the quick build-up feature you must drive slowly and cautiously until your brake reservoirs are charged to above 60 psi.

You can reduce the risk of leaving on a call with low air pressure by always connecting the air brake system to an external air supply whenever it is in the station.

Auxiliary Braking Systems

If your apparatus is over 36,000 lbs. GVW, it will be equipped with one of the following auxiliary brake systems:

- Allison transmission retarder.
- Telma electromagnetic retarder.
- Jake Brake.
- OEM Engine Compression brake.
- OEM Exhaust brake.

All of these system apply braking force through the drive wheels only.

During slippery road conditions or inclement weather, an auxiliary braking system may cause rear wheel lock-up and loss of vehicle control. Turn your auxiliary braking system(s) off before encountering slippery conditions.

If you forget or fail to turn off your auxiliary brake in slippery conditions and begin to lose control, apply the service brakes and make a safe stop. If the ABS senses a loss of braking control it will disengage the auxiliary brake and initiate an ABS event, helping you maintain control.

Descending Steep Grades

You should use a combination of service brake application, transmission down-shifting, and auxiliary braking when descending a steep grade. Anticipate steep grades and downshift before you begin to descend. Downshifting to a lower transmission range increases engine braking and helps you to maintain control. Apply the vehicle brakes or other retarding device to prevent exceeding engine governed speed in the lower range selected. Service brakes can overheat and lose effectiveness if used too much. To help avoid loss of control, use a combination of downshifting, braking, and other retarding devices.

Electronic Stability Control

Your apparatus may be equipped with an Electronic Stability Control (ESC) system. This system knows which direction you are pointing the wheel and pumps the brakes appropriately to help point the apparatus in the direction that you are turning. Under certain conditions ESC may also reduce engine power momentarily. This system is most effective on slippery surfaces.

ESC cannot prevent accidents or loss of control of the vehicle. You can still exceed the physical limitations of the system with either excess speed or extreme cornering, causing a loss of directional control or rollover.



Parking Brakes and Wheel Chocks

Your apparatus has a parking brake knob that must be engaged any time you leave the driver's seat. You must always place the transmission in Neutral (N) and then engage the Park Brake. As soon as you leave the cab, you must chock the wheels. Wheel chocks will help keep your apparatus from rolling in the event that the parking brakes malfunction or are released unintentionally.

Auxiliary Front Wheel Lock

Your apparatus may be equipped with an auxiliary front wheel lock system. The auxiliary front wheel lock feature uses air brake system pressure to keep the front brakes applied while parked. This system uses air pressure (rather than a passive spring) to keep the front brakes engaged and should only be used with the engine running and a qualified attendant present at all times. This feature is meant to enhance the parking performance of the vehicle, but it does not take the place of the spring brakes or the act of chocking the wheels. Always use wheel chocks.

Backing Your Apparatus

According to the National Safety Council, one out of four vehicle accidents can be blamed on poor backing techniques. Avoid backing hazards by planning ahead and avoid situations where you will need to back up:

- Choose pull-through parking spaces.
- If parking in an alley, back into it so that you are pulling forward onto the street when you leave.

Before backing:

- Get to know your vehicle's blind spots. In a typical truck, blind spots can extend up to 16 ft. (4.87 m) in front of and 160 ft. (48.76 m) behind a vehicle. Use a helper who can walk around your vehicle while it is parked to get to know when you can and cannot see them. Remember, mirrors can never give the whole picture while backing.
- Check for people, children or obstructions in the area.
- Check for soft soil, potholes, tire hazards, low hanging trees, powerlines or other dangers.
- Agree with your spotter that they will use hand signals and make sure your both understand their meaning.
- Equip spotter with reflective vest or other reflective gear.

SAFETY

- If backing at night, provide spotter with illuminated wands.

While backing:

- Use a spotter to assist.
- Don't allow your spotter to walk backwards while giving instructions.
- Keep your spotter in your mirror and don't let them stand in the path of your apparatus.
- Place your transmission in reverse and listen for the back-up alarm before taking your foot off the brake.



PARKING SAFELY

Parking On a Grade

Park on level ground whenever possible. Never park on a steep grade (a grade that is more than 20 percent). A 20 percent grade means that the ground rises one foot vertically for every 20 ft. (6.10 m) of horizontal distance. Your apparatus is not designed to park safely on any grade that is steeper than 20 percent.

When parking on any grade, set the parking brake and then remove your foot from the service brake pedal slowly. Observe the ground to make sure your apparatus is not moving. If your apparatus moves, relocate your apparatus to a more level location. Chock your wheels immediately upon exiting.

Park Away From Fire

When positioning your apparatus at a fire scene, be aware of where the fire is and where it is likely to spread. Park up-wind from the fire and in an area where the apparatus will be protected from direct heat and flames. High heat will melt lights, damage paint and, in extreme cases, catch the apparatus on fire.

Burning embers in the engine air filter can start the engine and vehicle on fire. Your apparatus is equipped with an ember screen to reduce the likelihood of burning embers catching the air cleaner media on fire, but it is not a guarantee. Determine where the air intake opening is located on your apparatus and avoid running the engine in an ember rich environment to minimize any possibility of catching the rig on fire.

Park Away From Fuel Vapors

Your apparatus is powered by a diesel engine. A diesel engine does not require a spark for ignition and will continue to run as long as there is fuel available. If you run your engine in an atmosphere that is laden with fuel vapors, such as at a fuel spill or gas leak, the engine may increase speed uncontrollably. If turning the ignition switch or battery switch OFF does not cause the engine to stop running it may be in a runaway situation. The only way to stop the engine in this situation is to eliminate the fuel source. Engage the emergency engine stop (if so equipped), eliminate the source of the fuel vapors, or cover the engine air intake to starve the engine of air and vapor.

Leaving Apparatus Unattended

Never leave your apparatus unattended. If your apparatus includes an aerial device, stow the aerial and retract the stabilizers. Park the apparatus in a secured location, and take other precautions as necessary to ensure that unauthorized personnel are prohibited from operating it.

Park Away From Power Lines

Look up and live. Always check the area and identify power lines before positioning your apparatus. Make sure you are well clear of power lines before raising equipment such as aerial devices or light masts. Never climb onto the apparatus if it will bring you closer than 20 ft. (6.10 m) from an overhead wire. Overhead power lines are not insulated. Some lines have a weather covering and appear to be insulated; they are not.

You or your apparatus do not need to touch a power line to be energized. Electricity arcs across ionized paths of air when a conductor is close enough. Consider all overhead wires or cables to be hazardous and dangerous. Never touch the outside of a vehicle you suspect may be energized while you are standing on the ground. Electricity will flow from the vehicle through you and into the ground. Move away from the vehicle and stay away. Warn others to stay away.

Unless the vehicle is on fire, it is safer to stay in the charged vehicle than to attempt to exit. If it is necessary to exit the vehicle, jump as far away as possible while landing with both feet together. Maintain your balance. Fall forward and away from, rather than backward and towards the vehicle. Once clear of the vehicle, don't return until a power company representative confirms that it is safe and that the line has been de-energized and grounded. Do not attempt to rescue a person in or on a charged vehicle.

- Look up and live.
- Stay in or on a charged vehicle.
- Stay away from vehicles charged by power lines.
- Keep vehicle, people and equipment away from power lines.

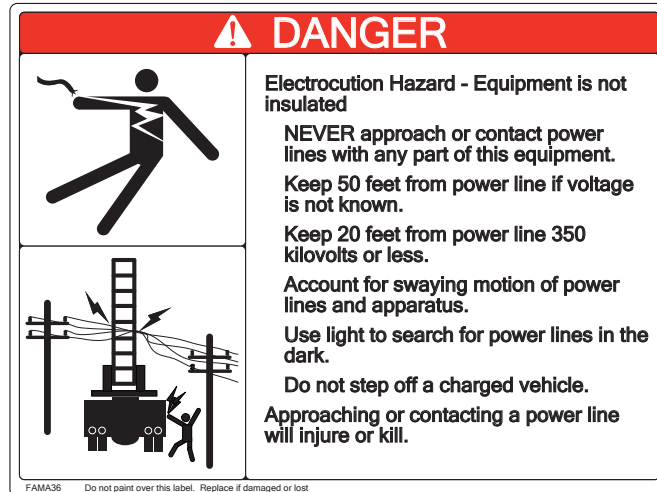

Idle Mitigation

Your apparatus may be equipped with idle mitigation technology to improve fuel economy and reduce the carbon footprint of the apparatus. This system shuts the main chassis engine off and then starts it again when the idle mitigation batteries require recharging. When the engine starts, the fan, belts, and other components will spin. Keep hands, clothes and other body parts clear of all powertrain components. Never crawl or work beneath your apparatus or work near your apparatus powertrain unless the ignition switch and the battery switch are both in the OFF position. Use lock-out tag-out procedures before servicing or maintaining.

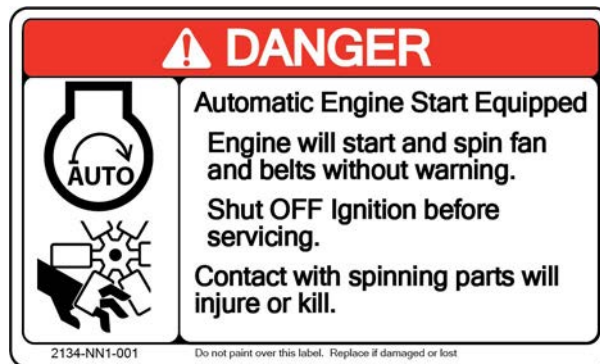

Winch and Rope Anchors

Your apparatus may be equipped with a hitch receiver or other device intended to anchor a portable winch or to be a tie-off point for rope operations. Pulling in a direction other than a straight line away from these anchors must be done with extreme caution. Your anchor is designed for maximum pull in a straight line away from the apparatus only. Align your apparatus with the pull or the capacity of the anchor will be significantly reduced and you risk an anchor failure.

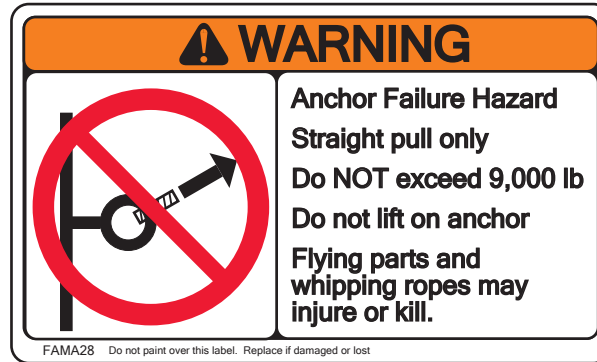

FUEL SAFELY

Before fueling, turn off the engine. Put your apparatus in neutral, set the parking brake, turn off the ignition switch, and chock the wheels.

Use only ultra-low sulfur diesel fuel (15 ppm sulfur).

Disable or turn off any auxiliary sources of ignition such as on-board fuel operated line voltage generators or fuel-fired heaters.

Do not smoke, light matches or lighters while refueling.

Use only the refueling latch provided on the dispenser nozzle.

Stay at the nozzle until the tank is full.

Never blend gasoline, gasohol and/or alcohol with diesel fuel. This practice creates an extreme fire hazard and under certain conditions an explosive hazard.

Check and fill the DEF tank with DEF if required.

Never add DEF to the Diesel fuel tank, and never add Diesel fuel to the DEF tank. In either case severe engine and/or emissions system damage will occur.

BEFORE PLACING YOUR APPARATUS IN-SERVICE

No truck should be placed into service if there is any doubt or evidence of improper or inadequate function of any of the components or systems.

Install Electronic Equipment Properly

Do not add electrical devices to your apparatus unless they are installed by qualified service technicians who understand how to provide proper circuit protection. Always replace fuses or circuit breakers with the correct size. Improper fuse or circuit breaker sizing can cause wires to overheat and burn.

Do Not Install Equipment in Air Bag Path.

If your apparatus includes Inflatable Occupant Restraints, determine where each of the air bags is located, and where their deployment path will be. Never mount equipment in the path of an air bag. This includes the following areas.

- The outboard area between a seat and the side of the cab.

SAFETY

- Between the front passenger seat and the dash (officer knee area).
- Between the driver seat and the dash (driver knee area).
- Under any seat suspension.
- On the steering wheel.

Install Front Bumper Mounted Equipment Properly

Avoid mounting equipment in a manner that blocks airflow to the grill. Large items blocking air to the grill may degrade cooling performance and cause the engine to overheat during heavy use and high ambient temperatures.

When mounting equipment to the bumper deck plate of a tilt cab, consider the motion of the cab when tilting to avoid interference in the tilted condition.

When mounting equipment to the bumper deck plate, do not block headlights, warning lights or flashers, turn signals, and side markers. Blocking any of the above can put the apparatus and personnel in danger of a collision that may cause injury and/or death.

Install Cab Interior Equipment Properly

Consider the effect of cab tilt on equipment storage to avoid damage from items falling forward when the cab is tilted for service or maintenance.

Monitor the weight of items installed in a tilt cab, or stored in tilt cab storage areas. Too much weight inside the cab may prevent the cab from being tilted for service or maintenance.

Refer to NFPA guidelines when mounting equipment inside the cab to avoid unnecessary risk of injury from flying objects during a collision.

Use caution if drilling into cab walls and headliners to mount equipment, as there may be wiring, heater hoses, or air conditioning hoses hidden beneath the surface.

Never mount any equipment in the deployment path of an air bag, seat belt pretensioner, or suspension seat pull-down device.

Install Air Pressure Operated Equipment Properly

Any air-operated equipment must only be added to the air system downstream of a pressure protection valve.

Consider the airflow requirements of any air-operated accessory that will draw pressure from the vehicle system. The engine air compressor output is but a fraction of its total capacity at engine idle and will not keep up with the continuous operation of most shop type air tools.

Pressure protection valves are installed in both front and rear brake systems to ensure that no other air pressure requirements of the vehicle are allowed to deplete the vehicle braking system capabilities.

Addition of any air pressure equipment added by the end user up-stream of these pressure protection valves will negate the conformance of the vehicle to this NFPA recommendation and property damage, personal injury and/or death could result.

Consider Dissimilar Metals When Mounting Equipment

Consider the metal types whenever mounting accessories. Dissimilar metals placed in direct contact with each other and subjected to moisture will form a galvanic reaction that will lead to rapid corrosion and possible failure of the mount, fastener, or base material. Select mounting material and fasteners to avoid dissimilar metals, or coat all mounting surfaces, base material, and fasteners with a commercial grade-rust proofing agent such as those conforming to MILC-0083933A specification.

Load your Apparatus Properly

Before placing the apparatus in service, load all compartments with the intended equipment and manpower. Top off all fluid tanks and obtain front and rear axle weights from a certified scale. Compare the results to the axle capacities listed on the Federal Motor Vehicle Safety Standard (FMVSS) information decal located inside the cab. In service weights must not exceed the axle capacities listed on the tag. If the scale weights are higher than the gross axle weight rating (GAWR) values listed on the label, move or remove equipment and re-weigh the apparatus until you are within the axle's limits.

Once you have each axle within its GAWR limits, obtain individual wheel weights and be sure you are within 7% weight difference from side to side.

Establish a routine of repeating the axle weight review at least annually to ensure that changes in equipment storage or other variables have not increase the axle loading beyond their placarded capacity.

Establish Correct Tire Pressure Values

Use the in-service axle weights to determine the correct tire pressure values using the latest information from your tire manufacturer (available on-line). Each tire manufacturer provides charts that will tell you the proper tire pressure for the load that the tire is carrying. Be sure to use the correct data based on your specific tire make, model, and size. Record the correct tire pressure settings on your vehicle inspection checklist. Adjust your tire pressure to match these values.

NOTICE

The tire pressure indicated on the FMVSS label located in your apparatus cab will be based on loading your tires to the Gross Axle Weight Rating (GAWR). If your apparatus in-service axle weight is less than the GAWR, then you should decrease the tire pressure to the correct value based on your in-service load. Failing to do so will reduce handling performance and lead to a rougher ride.

Leaf Spring Suspensions With U-Bolts

Your apparatus may be equipped with a leaf spring suspension at the front, the rear, or both. Leaf springs can settle during the initial run-in process, dropping by as much as 0.50 in. (12.7 mm) U-bolts must be tightened to their proper torque after the first 500 miles (804.672 km) of apparatus driving, or 500 miles (804.672 km) after a spring has been replaced.

Safety Equipment

Ensure that all of the safety equipment required by NFPA, your department policy, and applicable regulations are on the apparatus or available including:

- Personal Protective Ensembles.
- Fall Protection Belts, Tethers, or Harnesses.

SAFETY

- Wheel Chocks.
- Traffic Cones or Flares.
- Fire Extinguishers.
- Safety Vests.
- AEDs.

Demonstration and Training

Factory or dealer demonstration may be provided to familiarize you or a department with the apparatus. Training is the responsibility of the department and should include instruction, experience, and skills testing. All personnel that will operate the apparatus should have completed department authorized training in accordance with NFPA 1451 *Standard for a Fire and Emergency Service Vehicle Operations Training Program*.

PUMPER SAFETY

Storing, Deploying and Retrieving Hose Safely

Your apparatus may be equipped with hose storage areas. There are hazards related to stowing and laying hose and you must develop safe procedures for doing both.

Your department may choose to drive your apparatus during the hose laying or stowing procedure. This must be done with extreme caution and under the supervision of fire department authorities. Your apparatus is designed to transport personnel while seated and belted in the cab only. Any procedure that involves personnel riding on the apparatus, working around a moving apparatus or handling hose that is being dropped off a moving apparatus, involves risks that your apparatus was not designed to avoid. Understand these risks and develop your safety procedures accordingly. Your procedure should address the following risks:

Snags and Snarls

Hose storage areas may have structural features or components that can snag hose while it is being pulled out. Such features may include hose chutes, hose bed cover supports, emergency lighting, access steps, hand rails, pre-connect piping, etc. You will need to develop hose packing and deploying methods that will reduce the possibility of snags.

Pack hose carefully in any hose storage area to minimize the risk of hose or connections snagging or snarling during deployment. Hose that snags or snarls during deployment from a moving vehicle can whip violently, causing death or injury.

Slips and Falls

Develop hose practices that will protect yourself and others from slips and falls. This may include the use of auxiliary ladders, scaffolding, safety harnesses or other methods while stowing hose in areas that are high up on your apparatus.

Driving while Deploying

If you choose to drive your apparatus to deploy hose, never drive faster than you have determined to be safe, and definitely never faster than 5 mph (8 kph). Your apparatus is very heavy and powerful. It will not be stopped by a hose. If the end of the hose is held firmly to a hydrant or other object and the deploying hose catches on part of the apparatus, the hose in between will whip violently and forcefully causing damage, injury or death.

Do not stand on or near hose and hose couplings when vehicle is moving. Never wrap hose around you or others while deploying. Serious injury may result.

Driving while Retrieving

Do not reload hose by backing the vehicle up while personnel are walking behind the vehicle. This is an extremely hazardous practice. Drive forward over the top of the hose so that you can always see where you are driving. Stop after each section has passed the rear bumper, place the transmission in neutral, and apply the parking brake. Only when you are sure the vehicle is stopped and the parking brakes are set should you signal that it is safe for personnel to approach the apparatus and load the section of hose that is now behind the vehicle. When that section has been loaded, clear the area and drive forward over the next section. Repeat this process until all the hose has been loaded.

Consider other methods such as using hose rolling devices that make it easy to roll each section of hose and wheel it by hand to the parked apparatus. Whatever method you choose, always place the safety of your crew ahead of time or efficiency considerations.



Hose Bed Covers

Your apparatus may be equipped with solid hose bed covers. These covers are heavy and will be affected by strong winds and the grade the vehicle is parked on. The vehicle should be parked on level ground when the cover is lifted. Do not lift the cover in strong winds. Use two people to lift the cover. Make sure the cover restraining devices are in place and secured before releasing the hold of the cover. Make sure personnel have a secure hold of the cover when releasing the restraint device. Failure to follow these instructions could result in serious injury.

SAFETY

USING HOSE SAFELY

Hose on the Fire Scene

If your apparatus is equipped with a pump it can produce very high water pressure. Fire hose under pressure can burst without warning. Use only tested hose with your apparatus and never straddle or stand over a charged hose. Hose fittings can fail without warning. Inspect hose fittings for cracks, chips or other damage and replace when worn or damaged. An uncontrolled hose discharging foam or water will whip violently. Never pressurize a hose unless the discharge nozzle is closed and the nozzle is held or secured firmly.

Testing Hose

Your apparatus was never designed to be a hose testing device. While NFPA 1962 Standard for the Inspection, Care and Use of Fire Hose, Couplings and Nozzles and the Service Testing of Fire Hose does include a procedure for using a stationary pump or apparatus for hose testing, we recommend employing a proper hose testing machine as a much safer alternative. Hose test machines can develop the required test pressure at very low power levels. Since the whole point of hose testing is the assumption that your hose has seen service that might render it incapable of standing up to the test pressure, it is much more prudent to perform hose tests with the proper equipment. WE CANNOT BE RESPONSIBLE FOR INJURY IF YOU DECIDE TO USE YOUR APPARATUS TO TEST HOSE AS YOUR APPARATUS WAS NOT DESIGNED TO DO SO SAFELY.

DISCHARGE WATER SAFELY

Your water pump is a powerful machine which can hurl many tons of water every minute. This type of power can do great good in suppressing fire, but it can do great damage if not handled properly. Always treat pressurized hose and piping with the greatest respect and be thoroughly trained on safe pumping procedures before operating your pump. Be sure to avoid the following potential hazards:

Water Stream

You should use water streams for fire suppression only. Never direct your water stream at a person. Never open a discharge valve where the stream could strike a person. Water streams may knock people to the ground, causing injury or death.

Power Lines and Fire Suppression

Water is a conductor of electricity. Recognize the ability of water to conduct electricity. Never spray water around high voltage electrical wires. Electricity can travel down a water stream. Never spray water or foam through or onto live electric wires.

Boiling Discharge Water

It is essential that you always keep your pump water cool. This means that you must always circulate cool water through the pump. Your apparatus may include a recirculation valve that must be opened, or your apparatus may require the tank-to pump valve be open and the tank-fill valve to be opened slightly. You must know how your pump works and the necessary steps to keep the water cool. A pump without a constant supply of cool water flowing through it can quickly overheat the water. Hot water and steam may cause severe burns if overheated water is discharged on you or another person.

Matching Equipment to Pump Pressure

Your apparatus was manufactured with fittings, valves and piping connections as specified by your department. You must be sure that fittings, valves, connections, hoses and nozzles that you use with your apparatus are compatible, tested and capable of the flow rates and pressures that you will be using them with. Hoses, valves and fittings can explode if pressure capacity is exceeded. Never exceed the working pressure of downstream devices.

Pump Operation

Your pumping apparatus will power the pump using either the main truck driveline, a power-take-off from the engine or transmission, or a separate dedicated engine. You must study and learn how to properly engage, disengage and operate the pump on your apparatus. As a custom apparatus, every pump control layout may be different as specified by your department. The operation of your pump was demonstrated by your apparatus dealer at the time of delivery to members of your department who are responsible for training you in proper operation. Also study the IFSTA *Pumping and Aerial Apparatus Driver/Operator Handbook* to learn critical information on proper pumping procedures.

Emergency Pump Procedures With Failed Engine Control

Your apparatus may control pump pressure with a manual engine control and a relief valve or with a pressure governor. In either case, you should learn what to do if your primary pump control fails. Many apparatus can continue to pump after a control system failure by stationing an operator in the driver's seat and having them control engine speed with the foot accelerator. This procedure can be used in an emergency, but the firefighters on the lines should be immediately recalled from imminent danger, and the apparatus should be replaced on the fire scene as soon as possible. Take great care to keep a steady foot on the pedal to avoid sudden fluctuations in pressure.

Pressure Fluctuations

Sudden changes in water pressure are hazardous to firefighters at the end of a hose. Rapidly fluctuating pressure in a fire hose can cause the hose to whip. You must learn to avoid the many causes of pressure fluctuation including:

- Turning off a pressure governor.
- Sudden adjustments to engine speed.
- Opening or closing valves too quickly.
- Failing to remove air from pipes and hoses.

Always bleed the air from the intake lines before opening the intake valve at the apparatus. Stay alert for fluctuations in hose pressure and react quickly and safely when they do occur.

SAFETY

Intake and Discharge Caps

Your pumping apparatus may be equipped with either threaded or Storz-type couplings. In either case, you must avoid the hazard of removing intake or discharge caps that have pressure behind them. Intake and discharge caps can trap pressure if the valve controlling the connection is opened and then closed again when there is pressure in the system. This pressure can remain trapped between the cap and the valve for a long time. Always open the drain or bleeder valves first to relieve any pressure that may be trapped behind the cap before attempting to remove it. Open caps slowly and never stand in front of a cap during its removal. If you open a cap with pressure behind it, the cap may blow out at you with extreme force. You or others may be injured or killed.

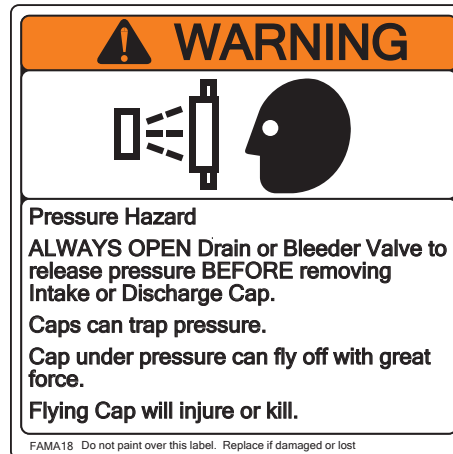

Pump and Roll

Your apparatus may be designed to Pump and Roll. This means that you can discharge water while the apparatus is moving. This may be beneficial for fighting grass or wildland fires. While the apparatus may have this capability, you must take particular care if you use this capability.

Remember that your apparatus is designed to transport personnel only if they are seated and belted. You should only discharge water from a moving apparatus by using a method approved by the National Fire Protection Association. If you choose to move the apparatus with firefighters using charged lines walking with the apparatus, use the following precautions:

- Drive at slow speeds only.
- Always stay clear of a backing vehicle.
- Never walk in front of a moving vehicle.
- Keep walking personnel alongside the apparatus and in view of the driver at all times.
- Keep walking personnel far enough from the apparatus so that they won't be crushed if the apparatus were to roll onto its side.
- Develop and practice procedures to get walking firefighters quickly into the apparatus and belted into a seat in the event that the fire shifts, and you need to retreat from the area.

High Pressure Two-Stage Pump

Your apparatus may be equipped with a two-stage high pressure pump. A two stage pump can be operated in the VOLUME mode at typical municipal fire suppression pressures of 80 to 120 psi (551 to 827 kPa). In the PRESSURE mode, this same pump can discharge at pressures up to 600 psi (4136 kPa), useful for charging standpipes in high rise structures. Normal fire suppression hose, nozzles, wyes, and other appliances are not likely to be rated for these high pressures. Train your personnel to use only specially rated high pressure hose and components when operating in the PRESSURE mode.

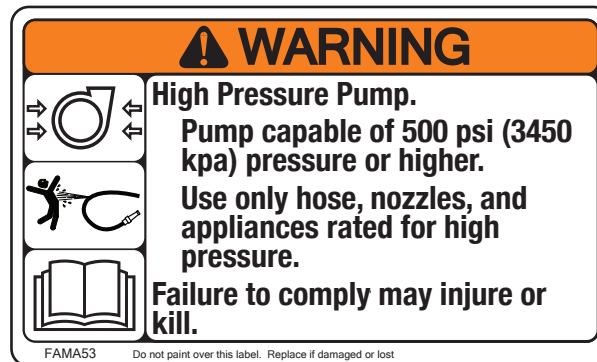

Ultra-High Pressure Water Stream

Your apparatus may be equipped with Ultra High Pressure (UHP) streams of water or foam solution to fight fires. UHP presents unique hazards and should be used only by trained, safety-conscious personnel. UHP water or foam solution is discharged at pressures over 1,000 psi (6894 kPa). At this pressure, the discharge stream may be capable of puncturing human skin, thus entering the blood stream. Personal protective equipment (PPE) such as gloves, turn-out gear, boots and a mask with a face shield should be worn whenever using UHP.

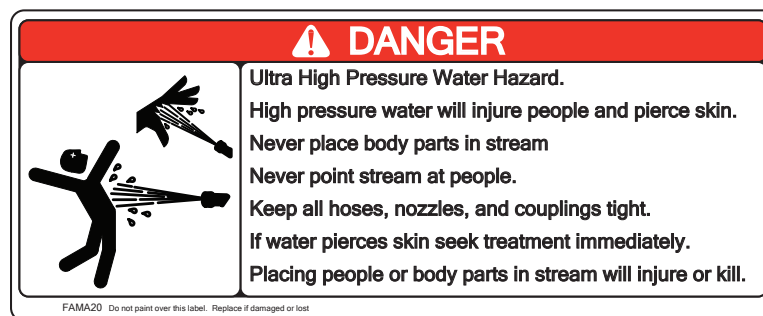

Tighten all fluid connections before operating this equipment and check the hoses, nozzles, and couplings after every use. A leak in a high pressure line can inject fluid into human skin just as it can from the nozzle. Never search for leaks with your hands or other body parts. Use a piece of wood or cardboard to detect leaks, keeping hands and other body parts well away from the potential source of the leak. Replace worn, damaged or loose parts immediately.

Ultra-High Pressure Piercing Equipment

Your apparatus may be equipped with an ultra-high pressure device used for piercing structural material. These devices use an aggregate added to the water stream that will cut through solid objects. It will also cut through skin and bones. Use safety precautions and treat a UHP piercing device with all the respect you would use with a firearm.

SAFETY

Foam Concentrate Types

If your apparatus is equipped with a foam system, you should know and understand the type of foam solution that it's capable of using. Never mix brands or types of foam concentrate, or the foam produced may not be adequate for the fire suppression capability desired.



Water Monitor

Your apparatus may include a water monitor on the front bumper, cab roof, apparatus top, or other location. You may also choose to use a ground monitor when pumping. Following these practices when discharging water from a monitor:

- Charge your monitor slowly. Rapid charging may cause a pressure surge which has the potential to cause an injury, or damage the monitor.
- Aim your monitor in a safe direction before discharging water.
- Never direct the stream at power lines or people.
- If there is a nozzle attached, ensure that it is tight and not over tightened before using the monitor. Do not use with a loose nozzle. A loose nozzle is a dangerous projectile. Ensure the thread on the nozzle swivel matches the thread on the monitor outlet. Do not over tighten the nozzle onto the unit.
- Read and follow the warning tag instructions on the lock pin lanyard.
- Do not exceed the maximum pressure or flow ratings of the monitor. Exceeding these ratings may lead to an injury or may cause damage to the monitor.
- If not equipped with the automatic drain valve, drain the monitor after use to prevent freeze damage.

Ground Water Monitor

In addition to the above instructions, a ground monitor (water monitor not attached to your apparatus), must be properly secure staked down or otherwise secured before use. Water discharge force will cause a loose monitor to fly about with great force causing injury or death.

AERIAL SAFETY

Your aerial device is a very complex machine that requires specific knowledge, training and experience to operate safely. You must study and learn how to properly set up and operate your aerial device. Study this manual and the IFSTA *Pumping and Aerial Apparatus Driver/Operator Handbook* to learn the proper procedures.

Emergency Stop Feature

Your aerial device will have an emergency stop (E-Stop) feature at the primary operator station controls. This may be a switch on the panel, or an operator present foot pedal. This is a very important safety feature on the aerial. If something goes wrong and the aerial is behaving in a manner you don't understand, use the emergency stop feature to stop all aerial functions.

Once aerial functions have ceased, clear personnel from the area and determine what is wrong before resetting the emergency stop feature and continuing operation. Practice using the emergency stop feature during training sessions until it becomes second nature so that your mind will react quickly in an emergency.

Emergency Power Unit

Your aerial device uses power supplied by a hydraulic pump that is driven by a power take-off from the engine. It is always possible that a mechanical, electrical or hydraulic failure can occur that will interfere with the operation of your aerial device. The Emergency Power Unit (EPU) will provide back-up power and, in most cases, allow you to continue operation until you can recall personnel from harm's way, stow the device and remove it from the fire scene for repair. Do not rely on the EPU for extended use as it is not designed for continuous operation.

Over-Ride Controls

Your aerial device has certain over-ride features that will allow "out of the ordinary" operation in certain cases of equipment malfunction. You should learn where these controls are located and how to operate them. Practice using your override controls until you are just as proficient with them as you are with the standard controls.

If the normal control system does malfunction, recall personnel from harm's way immediately and take the device out of service until it can be repaired. Use emergency override controls with extreme caution and only when all non-essential personnel are well clear of any hazard.

Interlocks

Your aerial apparatus will be equipped with a number of interlock functions, many of which are required by NFPA 1901 Standard for Automotive Fire Apparatus. Interlock devices are intended to reduce the possibility of unsafe actions, but they should never take the place of careful, thoughtful and prudent operation. Interlocks rely on the proper functioning of sensors, wiring, relays and computers. These are physical components that have finite lives and can fail from a number of causes such as wear, corrosion, accidental damage or aging. You should identify each interlock and develop a procedure on how to safely ensure that each is functioning.

Aerial device interlocks may include:

- **Stabilizers Set:** The aerial device will not operate unless the stabilizers are deployed.
- **Nozzle Stow:** Device will not drop into the cradle if the master stream nozzle is not properly positioned.
- **Body Collision:** The device will not move into regions where it would make contact with the body or cab.
- **Maximum Elevation Slow-Down:** The device will slow down prior to reaching maximum elevation or extension.

SAFETY

- **Rotation Interlock (Short-Jack):** The aerial device will not rotate over the side of the apparatus where the stabilizers are not sufficiently extended.
- **Tiller Operator Interlock:** Engine starter will not work unless the tiller operator is seated and belted, or a tiller cab start button is engaged.
- **Aerial Function Interlocks:** The aerial device will not operate until the parking brakes have been set, and the transmission has been placed in neutral, or the transmission is in the drive position with the fire pump engaged.

PREPARE FOR SAFE AERIAL OPERATION

Select a Site

Selecting the right spot to position your aerial apparatus is critical. You must anticipate fire ground needs and identify areas where to position so that the aerial tip can reach your intended targets. Select a position that will support your apparatus weight and meet all of the following criteria:

- Clear of areas exposed to falling debris.
- Clear of overhead power lines.
- Flat enough to allow leveling within the green or yellow zone.
- Firm and stable surface. Avoid loose objects, underground utility access covers, broken pavement and areas that drop off suddenly.
- Never position on a railroad track or an active airport runway.

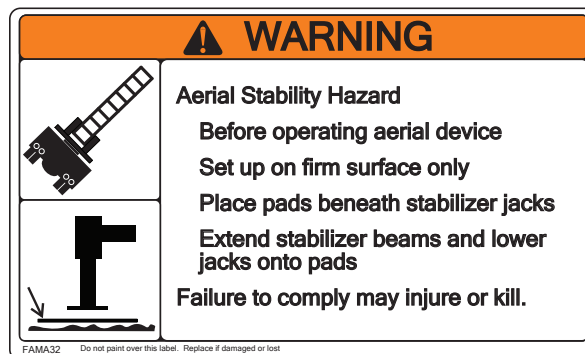



Set-Up

Once you have selected a set-up location, clear the area of personnel and use spotters to maneuver your apparatus into position. Follow the instructions in this manual to place your apparatus in operation ensuring the following:

- Use auxiliary stabilizer pads (If Equipped).
- Keep the stabilizers in your sight at all times while deploying. Use spotters if needed.

Setting Up Within Safe Limits

Your aerial device must be within a few degrees of being level for safe operation. Check your level indicators to make sure that the device is properly leveled. The correct angle reading is where the center of the ball lines up with the gradation lines marked on the tube.

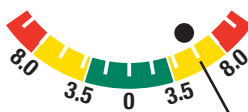

Correct Reading of this example indication is 6 degrees.

Figure 2-1. Level indication of 6 degrees

You can still operate safely even if your device is not perfectly level, but only if you keep it within the safe limits as indicated on the load chart for either the green or yellow zone. Do not operate with either the front-to-back or side-to-side level indicators in the red zone.

Table 2-2: Working Zone

Level Indicator Reading		Working Zone
Front-to-Back	Side-to-Side	
Green	Green	Green
Green	Yellow	Yellow
Yellow	Green	Yellow
Yellow	Yellow	Yellow
Yellow	Red	Red
Red	Yellow	Red
Green	Red	Red
Red	Green	Red
Red	Red	Red

Avoid operating your ladder in a condition where the ladder rungs are not level to the earth as this will make climbing more difficult.

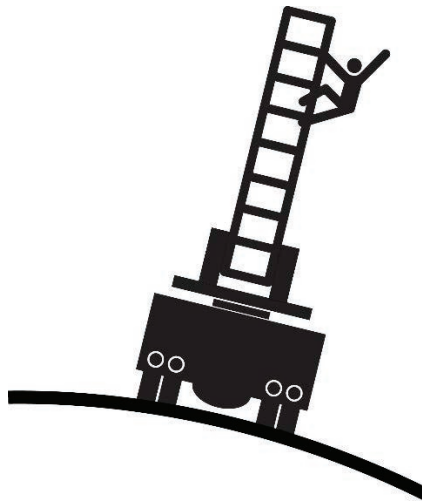

Short-Jacking

Your apparatus may allow for partial extension of the stabilizer beams. Partial extension may result in no operation on that side of the apparatus. (A short set condition.) Apparatus equipped with the Multi-Stance™ system may allow for reduced loads on the ladder. This capability allows your apparatus to be set up in an area where obstructions or surface conditions do not allow them to be extended completely on one side.



Figure 2-2. Short Set Rotation Interlock Stop Points

Set up the apparatus so that the stabilizers can be sufficiently extended in the direction that you will be working and extend them as far as possible on the opposite side. If a stabilizer beam is not extended far enough to achieve a load rating, you will not be able to safely rotate the device over that side. Whenever possible, a safety officer should observe aerial operations when you are using short-jack procedures.

OPERATING YOUR AERIAL SAFELY

Primary Control Operator

Operation of your aerial requires a qualified operator to be stationed at the primary controls on the turntable of the device at all times. You must also have a qualified operator at the controls any time there are personnel on the device, even if the device is not moving. The primary operator must be thoroughly trained, experienced and authorized by your department to perform primary control operation. A primary operator at the turntable controls is responsible for the safety of the operation, and is there to make immediate changes as needed to avoid imminent or changing hazards such as:

- Heat.
- Flames.
- Wind speed.
- Icing conditions.
- Wind and smoke direction.
- Power lines.
- Structural obstacles.



Secondary Control Operator

Your apparatus may have secondary controls at the tip of the ladder or at the platform bucket. These controls are only meant to be used with an authorized operator still at the primary controls. The primary operator must be prepared to override the tip or platform bucket operator if unsafe conditions are encountered. Both operators should be in communication with each other and with other personnel on the device at all times. If your apparatus is not equipped with a platform, keep the aerial ladder extended and use the fold-down steps with toe-guards and keep your fall protection tether secured to the device.

Use of a Spotter

During operation you may find that you are not able to see clearly through smoke or fog, or due to obstructions located on the far side of the device from where the controls are positioned. In situations such as these, you must use a spotter. Agree upon and train using standard verbal commands and visual signals until the team can perform operations safely and efficiently. If multiple spotters are required to ensure that all blind spots are covered, practice methods of ensuring that only one spotter at a time is giving directions.

Avoid Overhead Power Lines

Power lines are everywhere, and they present an extreme hazard to you and your aerial device. Unlike utility bucket trucks, your device is not insulated and will conduct electricity. Electrical arcs will burn, maim and kill you and others on or around the device if you get too close to them.

- Look up and Live. Always watch for power lines overhead.
- If operating at night, use powerful lights to search for power lines or poles.
- Stay 20 feet from power lines less than 350,000 volts.
- Stay 50 feet from lines over 350,000 volts or if the voltage is not known.
- Account for the swaying or bouncing motion of both the power lines and the device.

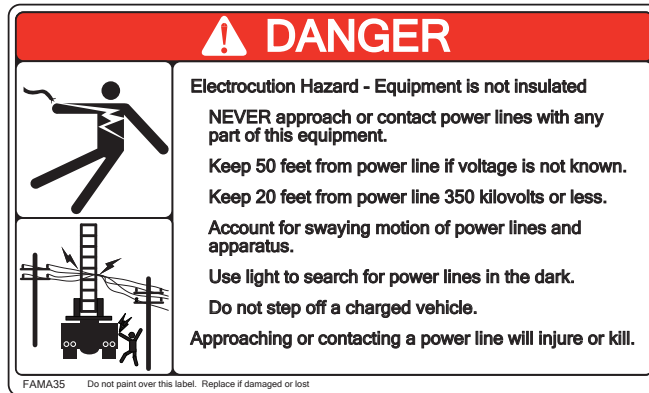

Extra Precautions Around Power Lines

If your apparatus is being operated around power lines you must take extra precautions. If the apparatus contacts a power line it will be electrified and the current will seek a path to the ground. If you are standing on the ground and touching the apparatus at the same time, you will be electrocuted. It is safer for you to be either completely on the apparatus, or completely off it and not touching it. If your apparatus includes a pump it will have a pump operator platform. Always stand on this platform while operating the pump so that you will be safer if your apparatus becomes electrified.

If Your Device Becomes Electrified

If you are on or inside a vehicle that becomes energized by a power line, stay where you are. Exiting the vehicle is more hazardous than remaining on it. Stay in or on the vehicle until a power company representative informs you that the line has been de-energized, grounded, and that the area is safe.

If it is critical that you leave the vehicle, JUMP as far away as possible, landing with both feet together. Maintain balance or fall forward; don't fall back towards the vehicle which could result in your body becoming a pathway between the vehicle and the ground. No part of your body should touch the vehicle and the ground at the same time.

If you are outside of the vehicle that contacts or is energized by a power line, move away from the vehicle, and stay away. Warn others to stay away.

Rungs Aligned

Before allowing personnel to climb a telescoping aerial ladder or the ladder section of an elevating platform, you must ensure that the rungs are aligned. This will allow personnel to maintain proper foot angle while climbing and avoid the possibility of their feet getting caught between misaligned adjacent rungs. Your controls will indicate when the rungs are properly aligned for climbing. Always observe your ladder rungs directly to ensure that they are aligned.

Fall Protection

Any time you are climbing your device or operating from the platform bucket you must be wearing a ladder belt and tether or other approved fall protection PPE. The belt or PPE should be properly sized to fit you, and the length of the tether should be selected by the fire department safety officer based on your department's procedures.

If you are operating from inside the platform bucket, tie off to a fall protection anchor indicated by this symbol:

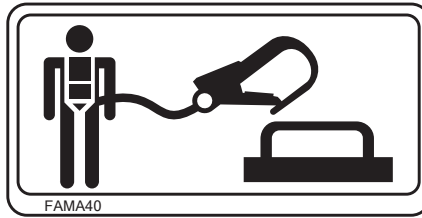

If you are on the ladder, tie off to a structural feature of the ladder such as a rung that will not allow the tether hook to slide downward. Do not tie off to non- structural features such as wires, cables, lights, brackets, etc...

You must be tethered to a structural feature of the ladder or platform bucket any time:

- The device is in motion.
- You are not actively entering or exiting the platform bucket.
- You are not actively climbing or descending the ladder (If you stop at any point during your climb, connect your fall protection to a ladder rung).



Climbing the Aerial Ladder

The National Institute of Occupational Safety and Health has considered the aspects around determining the optimum ladder elevation for climbing. NIOSH points out that there are several variables that must be considered when positioning an aerial ladder. One of these variables is the angle of elevation that is best for climbing. Steep angles of climb, even when kept within accepted standards, can make climbing and tool carrying more difficult for some persons.

Choosing an optimal climbing angle may require more than simply implementing a 1:4 or 75 degree angle "rule". This rule has been derived from OSHA standards that may not account for to the heights firefighters may climb nor the bulk, weight and positioning relative to the body of the tools that they carry. Firefighters' tools, PPE and SCBA place burdens on the body that should be considered. Adjust your angle of climb accordingly to minimize stress on climbers and allow them to maintain balance during the climb.

Use three points of contact and grasping the rungs as you climb. Grasping the rungs has several safety advantages over holding onto the rails:

- Your hands have more holding power when they are grasping a round bar than when they are grasping a rectangular object.

- If your feet slip and you are holding onto the rails, your hands may slide down the rails, and you may fall. If you are holding on to the rungs, it is more likely that your hands will have enough grip force to help you recover.
- If your feet slip and you are holding onto only one rail at the time, the weight of your body will be offset from your line of grip and your body will twist. If you are holding onto the rung, your grip force is lined up with your body, and your chance of staying in control is much greater.

There are four times as many falls from descending as from ascending a ladder. Pay close attention to your footing on the way down.

Water Towers

Your apparatus may be equipped with a water tower boom that is not equipped with a ladder and not designed to carry people. Keep personnel off the apparatus during any boom operation. The boom is designed for fire suppression only and is not designed nor equipped for carrying people. Do not climb or ride on this equipment, and do not allow others to do so.

- Do not climb or ride on boom.
- Do not lift people.
- Do not lift objects.

Boom Style Platform

Your apparatus may be equipped with a boom-style platform bucket that is not equipped with a ladder and not designed to carry people. Keep personnel off the boom during operation. The boom is designed for supporting the platform bucket only and is not designed nor equipped for carrying people. Do not climb or ride on the boom, and do not allow others to do so.

- Do not climb or ride on boom.
- Do not lift people.
- Do not lift objects.

Wire Rope Hazard

Your aerial device uses wire rope (cables) to extend and retract the ladder. Anywhere wire rope comes close to or contacts other mechanical parts such as pulleys, sheaves, roller guides or structural features on the device, a pinch hazard may exist. Anyone operating, climbing on, or supervising others on an aerial device that uses wire rope should study the wire ropes and follow these safe practices:

- Stay clear of wire rope, pulleys, and sheaves during operation.
- Never touch wire rope while someone else is at the control or during operation.
- Never touch wire rope while in tension or under load.



Operating With Personnel on the Aerial Ladder

You must never allow personnel to climb, ride or work on your aerial device unless they are thoroughly trained in safe operation and the importance of using the three points of contact method of climbing. Make sure that when people are climbing while carrying equipment that they have such equipment in their pockets or tethered to themselves in a way that allows them full use of both feet and both hands.

Before allowing climbers ensure that the ladder will not move. Do this using one of the following methods (depending on device design).

- Stand away from the controls.
- Lock the system using the system lock.
- Remove your foot from the operator present foot switch.
- Depress the Emergency Stop button or machine stop button.

Never extend or retract the ladder with people on the ladder unless they are at the secondary operator station at the ladder tip and their feet are securely on the supplied folding step(s). Never retract the ladder past where the section overlaps the secondary operator position. Extending or retracting the ladder with climbers on the ladder will crush their hands or feet.

Never rotate, raise, or lower the device unless personnel are secured to a structural feature with a ladder belt and tether.

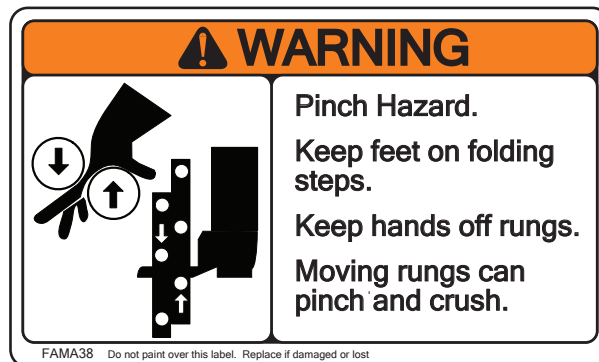

Ladder Base Pinch and Crush

Your aerial device is made from heavy structural parts that are constantly moving past each other during operation. This creates dangerous pinch or crush hazards all around you. You must study your device carefully and keep yourself and others well clear of these areas during operation. Never allow people to hold onto or lean against the device while they are waiting for you to position it.



Operating with Personnel Near the Aerial

There may be times during operation when other personnel are working in the same vicinity. Instruct and train your department personnel that they should approach a working aerial device apparatus only after getting the all-clear from the primary control operator. Keep personnel clear of swinging structures and other moving parts. Keep them away from the area beneath the device and from around the apparatus. Items accidentally dropped by personnel on the device may injure or kill those below. Falling items may bounce off the ladder, turntable or other parts of the apparatus and strike personnel at some distance from the apparatus. Take extra precautions during icing conditions to keep personnel from being injured by ice falling from the device.

Operating Within Safe Limits

Your aerial device will have a load chart that is specific to your device make and model and will be located near the primary operator station. You must study and memorize your load chart so that you will not need to refer to it constantly during operation. The load chart criteria should be so familiar that you can instantly recognize when the device is nearing a critical or overload condition.

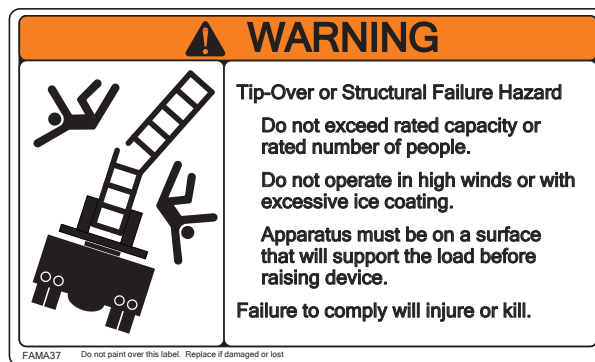

Your load chart will tell you how many people you can have in various locations on the device depending on the elevation of the device, whether you are flowing water or not, and whether you are leveled within the green or yellow zones. Your device can support more people as the angle of elevation increases.

SAFETY

The safety of your operation also depends on factors that cannot be measured precisely and may change rapidly including:

- Level condition (Green or Yellow).
- Monitor water flow and direction.
- Wind speed.
- Wind gusts.
- Ice build-up.

You must be familiar with conditions that will reduce the capacity of your device and stay alert to changes in these situations.

You should always operate the device slowly, carefully and cautiously. Keep in mind that the load ratings on the chart are static ratings. This means that they assume only the weight of the personnel or equipment is acting on the device without bouncing or other sudden changes. Dynamic loading may be much higher than a static load. Do not allow personnel to bounce, swing or jump onto the device.

Load Chart Limits and People on the Ladder

Your load chart will indicate the maximum number of people that can be placed on each section of your ladder depending on the position of the device. Never exceed these limits.

Over 250 Counts for Two - the load chart is valid only if each person does not weigh more than 250 lbs. (113 kg) including clothing, gear, etc. If you have a person on your device who is significantly heavier than this value you must adjust accordingly. For persons who are heavier than 250 lbs. (113 kg) count them as if they were two people.

FAMA studies have shown that the average firefighter with PPE and SCBA weighs 250 lbs. (113 kg) NIOSH studies suggest this value may be even higher. Take the time to weigh your personnel in PPE, SCBA, and the equipment they will have while climbing so you know when to adjust for heavier personnel.

One Person One Rung - the load chart assumes that people on a ladder are never sharing a rung. Keep your climbers spread out appropriately.

Approaching Structures

Your aerial device is designed to handle loads in the downward direction only. It will be damaged if it is loaded by resting the tip on a structure, powering it down onto a structure, powering it into the ground, or by using it to span a structure like a bridge. It may also be damaged if it is rotated into a structure. Never use it as a battering ram to knock over structures, break windows, or for any purpose other than fire suppression or rescue operations.

Never push or pull sideways on your aerial device. Do not use it as a crane.

During rescue operations, always aim the tip of your device above the victim and the structure and slowly lower toward the target. Stop the device 6.0 in. to 12.0 in. (152.4 to 304.8 mm) above the target. Personnel weight on the device will then cause the device to settle onto or just above the structure without risking a reverse-loading condition.

Operating Above Structures

There are times when you may wish to extend your aerial device over the top of a structure. Do not do this if there is a risk of a flashover or sudden roof ventilation. You should never position the device over high heat or open flame as exposure to high temperatures will weaken structural members, melt wires and hoses, and present a hazard to personnel on the device.

Icing Conditions

If you are operating your aerial device in freezing temperatures, you must be alert to the possibility of ice forming on the device. This can happen from freezing fire streams, freezing rain, freezing fog, or snow that melts and then re-freezes. You must use extreme caution when retracting or extending an aerial device that is coated with ice, both for the safety of personnel and to protect the device from damage. Keep personnel clear of the path of falling ice. Move the device slowly to allow ice to fall away.

Inspect the device thoroughly after operation in an icing condition as the operation with an ice coating can damage many components of the device and render it unsafe for future use.

Windy Conditions

High winds can tip over any aerial device. See your load chart to determine what wind speed your device is rated for. You must then select a method that you will use to determine the wind speed while you are operating. The best method is a wind speed indicator mounted at the tip of the device. You can estimate wind speed in an emergency using the Beaufort Scale if your wind speed indicator quits working or is unavailable.

Table 2-3: Beaufort Scale (For Reference Only)

Beaufort Number	Description	Land Conditions	Wind Speed	
			mph	km/h
0	Calm	Calm. Smoke rises vertically.	0	0
1	Light Air	Wind motion visible in smoke.	1-3	1-6
2	Light Breeze	Wind felt on exposed skin. Leaves rustle.	4-7	7-11
3	Gentle Breeze	Leaves and smaller twigs in constant motion.	8-12	12-19
4	Moderate Breeze	Dust and loose paper raised. Small branches begin to move.	13-18	20-29
5	Fresh Breeze	Smaller trees sway.	19-24	30-39
6	Strong Breeze	Large branches in motion. Flags waving near horizontal. Umbrella use becomes difficult.	25-31	40-50
7	Near Gale/Moderate Gale	Whole trees in motion. Effort needed to walk against the wind.	32-38	51-62
8	Fresh Gale	Twigs broken from trees. Cars veer on road.	39-46	63-75
9	Strong Gale	Light structure damage.	47-54	76-87

Wind speeds usually increase the higher up you climb, and the wind speed at the tip of the device will have the greatest over-turning impact. Retract and stow your device before the wind conditions increase above the wind speed rating.

Just because your device is rated for a certain wind speed does not mean it is safe for people to be operating on the ladder or in the platform. High or gusting winds will be a hazard to climbers and people in a

SAFETY

platform bucket. Consider removing people from the device in high winds and using the device for water delivery only.

Flying Flags

Your department may wish to use your aerial apparatus for tasks it was not designed for. Any use other than fire suppression or emergency rescue is not recommended. Flying flags, for instance, is a popular practice, but the forces imposed on your device are unpredictable and may exceed the load chart ratings. The risk increases as the wind speed and variability increases. Your safety officer should study any such practice carefully and take responsibility for the safety of the apparatus and for personnel in the area. Never exceed the load chart ratings.

Lightning Threat

Your apparatus will not protect you from lightning strikes. To avoid the risk of death or injury, retract your device and seek shelter before lightning storms enter your area.

Rope Rescue

Your aerial device may be equipped with a feature to facilitate rope rescue operations. The top portion of this feature may be an anchor point on your platform bucket, or a pulley device that attaches to the tip of your ladder. The bottom portion of this feature may be a fixed tie-off appropriately labeled near the base of the ladder, or a Change of Direction Bar that attaches to the ladder near the base of the ladder. Only use these provided features and/or devices to perform rope rescue with your apparatus.

Your apparatus is not a crane, and it is not designed to be used as such. Refer to your apparatus load chart. The weight that you lift should never exceed the load chart ratings, and it should never exceed the rated capacity indicated on the rope rescue anchors or change of direction bar. Anchor points or devices provided with your apparatus are intended to be used as a single anchor for a single rescue rope only.

To ensure that the capacity is not exceeded, it is essential that you lift in a smooth manner, without causing the device or the load to bounce, jerk or sway. Use appropriate methods to stabilize the load while it is being lifted.

If you are using the pulley provided for rope rescue, or if you have attached a single pulley to the anchor on your platform bucket, the working end of the rope must follow along parallel with the ladder to the turntable anchor, or be passed through the Change of Direction Bar pulley properly attached at the turntable. In this configuration, the rope will be raised when the device sections are extended and lowered when the device sections are retracted. Never use additional pulleys or block and tackle as the load on the device will be multiplied.

The working end of the rope should never be anchored to other parts of the ladder, other parts of the apparatus, static structures, or to objects on the ground. If the rope is anchored to a point that is not in-line with the ladder, the load on the device will be doubled and you will exceed the ratings and overload your aerial device. Overloading will risk device damage, tipping or collapse leading to injury or death.

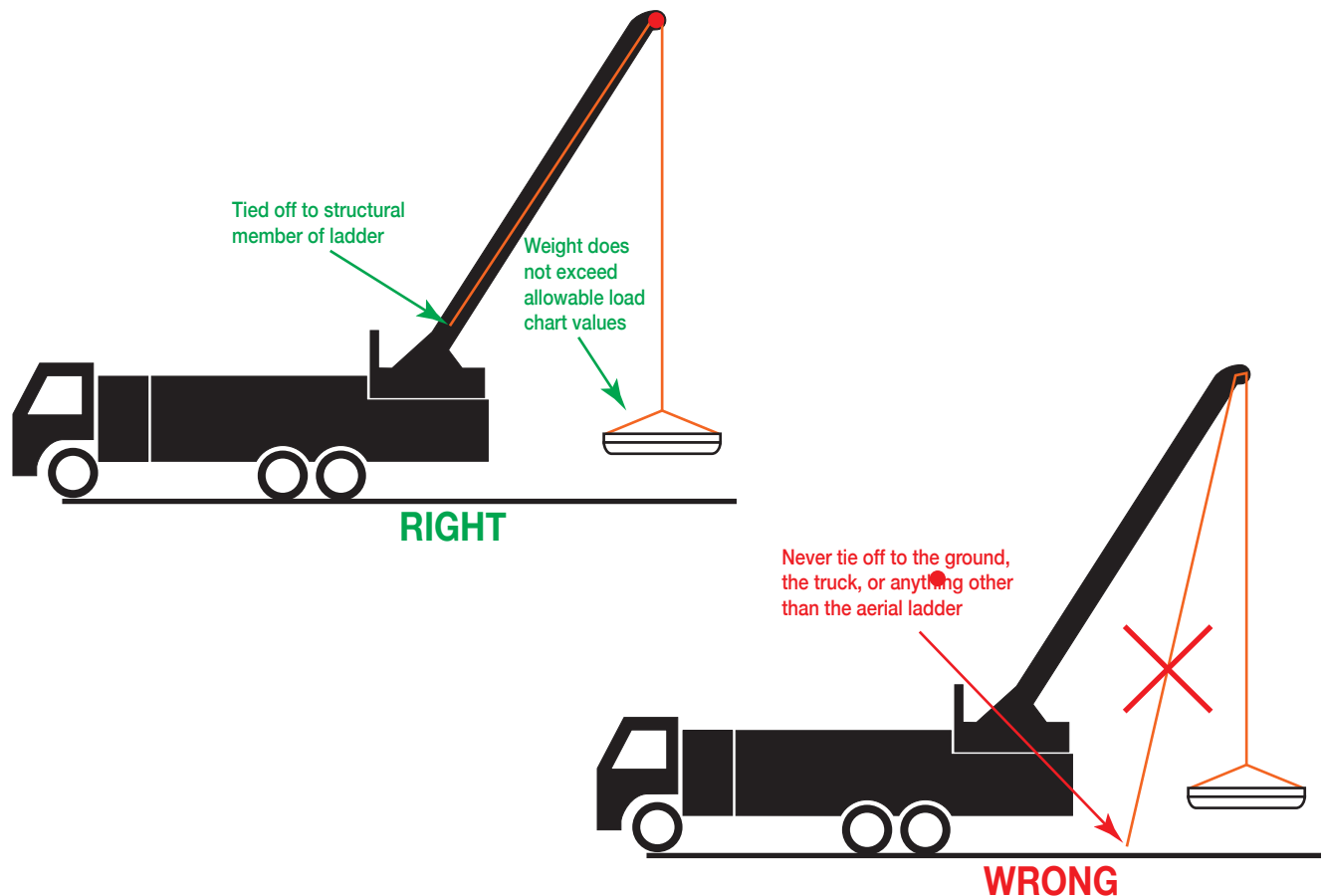

Proper rigging for rope rescue, attachment of ropes to rescue baskets, and all other operations involved in rope rescue other than those outlined in this manual are the responsibility of you and your department. Guidelines that you may find useful when determining how to safely perform rope rescue operations with your apparatus include:

- NFPA 1983 Standard on Life Safety Rope and Equipment for Emergency Services.
- NFPA 1670 Standard on Operations and Training for Technical Search and Rescue Incidents.
- IFTSA Fire Service Technical Search and Rescue manual.

Pre-Piped Waterway and Monitor

Direct your monitor nozzle at the fire and away from people. Charge the aerial waterway slowly to avoid excessive nozzle reaction forces on the aerial device. When stowing a monitor equipped with an adjustable stream nozzle, adjust the nozzle to the fog pattern to reduce the risk of the water stream striking people when the waterway is charged.

SAFETY

Waterway Monitor

Your device may be equipped with a pre-piped waterway that allows the monitor to be positioned at the tip for fire suppression, or on a lower section for rescue. If your device includes this feature, it is essential that you always be sure that the monitor is secured in its anchor. If water pressure is applied when the monitor is not securely anchored, the pressure will cause the waterway to extend rapidly on its own. The rapid movement of the pipe sections can damage equipment or harm people who may be on the ladder at the time. Study the waterway on your device, understand the monitor anchoring mechanism, and always be sure the monitor is secured prior to charging the waterway.

Aerial Ladder Pipe Operation

Your department may choose to use a ladder pipe nozzle supplied by a fire hose that you lay along the ladder rungs. Only use this method with extreme care and under the supervision of trained personnel who understand the extra loads created by the weight of the hose and the reaction forces of the nozzle. Use only ladder pipes designed for the application and follow all ladder pipe manufacturer operator instructions and fire industry best practices.

Lay the hose along the middle of the ladder so that it rests on the rungs only. Tie off the hose so that it stays in the middle of the ladder when charged. Never hang the hose off the side of the ladder. Never use more than one ladder pipe nozzle and hose on your aerial ladder. Do not use an aerial ladder pipe and fire hose on an apparatus that is equipped with a pre-piped waterway and water monitor.

TRACTOR DRAWN AERIAL OPERATIONS

Tiller Cab Safety

When operating from the tiller cab, follow the same safety procedures that you would follow if you are driving the tractor (see Riding Safety and Driving Safety in this manual) including the following:

- Seat Belts: Seat belts in good condition. Seated and belted prior to vehicle motion.
- Seat Adjustment: Seat adjusted to allow proper reach of operational controls.
- Doors: Doors fully closed and latched.
- Helmets: Helmet off and secured for travel.
- Equipment Secured: No loose equipment in the cab.
- Mirror Adjustment: Mirrors and/or cameras adjusted properly.
- Visibility Check: Glass clean and free of fog or ice, wipers operational, defroster operational.

Tiller Steering Lock

If your apparatus is a tractor-drawn aerial there are two ways in which the trailer can be towed, with the rear steering functional or with it locked. Always check the steering lock before placing the vehicle in motion unless you have a tiller operator at the wheel. Driving without a tiller operator while the steering is unlocked will cause the trailer to steer uncontrollably.

Never attempt to lock or unlock the steering with the apparatus in motion.

Tiller Steering

If you choose to operate your aerial tiller with the rear steering unlocked, you must have a tiller cab operator seated and belted prior to placing the apparatus in motion. The tiller operator must be alert at all times to keep the trailer tracking behind the tractor, or to avoid traffic and other road hazards.

Tractor Operator Training

Obtain a Class-A Commercial Driver's License or the equivalent fire department training and authorization prior to driving from the tractor position. This training must include the special aspects of driving a heavy combination vehicle.

Tiller Operator Training

The tiller operator must be trained, experienced, and authorized to occupy this role. Training should be conducted under supervision and in a controlled location.

Fifth Wheel Lock

Your tiller aerial apparatus may include a feature to lock the tiller trailer turntable connection (fifth wheel) from articulating up and down. It does not lock the connection from rotating. This locking feature is critical to providing stability while the ladder is being operated. This lock allows the weight of the tractor to contribute to stability. If you attempt to operate the ladder without the fifth wheel locked, the ladder could tip over.

The fifth wheel must be unlocked before moving your apparatus. Driving your apparatus with the fifth wheel locked would cause uneven loading on the axles. This could lead to serious driving hazards including reduced steering control, reduced braking control, and poor handling. Never place your apparatus in motion unless the fifth wheel is unlocked.

PERFORM MAINTENANCE SAFELY

Maintenance Records

The safety of your apparatus will depend on how well it is maintained, and good maintenance depends on keeping accurate maintenance and repair records. Maintenance and repair records should be maintained as permanent records and kept in a secure location. Acceptable records include itemized bills, dealer work orders, owner's vehicle log, and service facility receipts, stating the date service was performed.

Vehicle Identification Number (VIN), mileage (kilometers), engine hours, and service performed. Consult NFPA® 1911: *Standard for the Inspection, Maintenance, Testing, and Retirement of In-Service Automotive Fire Apparatus* for apparatus inspection and maintenance recommendations.

Use OEM Parts for Repair

- Your apparatus is designed to operate as a system. Every part has been selected to ensure proper performance. While some common service parts such as fluids and filters may be available from heavy truck supply sources, purchasing repair parts from any place other than your authorized dealership may put the safety or performance of your apparatus at risk. All safety-critical components should always be sourced through your authorized dealer including:
 - Chassis structural components.
 - Chassis steering, suspension, and brake components.

SAFETY

- Apparatus related electronics.
- Aerial and stabilizer hydraulic cylinders including valves and manifolds.
- Hydraulic rod-end pins, hardware, and locking devices.
- Ladder or boom slide pads.
- Aerial extension cables, sheaves, and anchors.
- Turntable rotation bearings, rotation gears, drive gears, and motors.
- Rotation sensing components (proximity switches, encoders, limit switches, etc...).
- Extend or retract sensing components (proximity switches, limit switches, etc...).
- Stabilizer extension sensing components (proximity switches, limit switches, etc...).
- Jack plant sensing components (proximity switches, limit switches, etc...).
- Wire harnesses and connectors.
- Wire bulkhead connector or other pass-through component for wires entering rung rails or hand rails.
- Corrosion inhibitor material for the interior of aerial ladder structural tubes.
- Mounts for securing equipment on the device (pike poles, roof ladders, etc...).
- Safety signs, load charts, and other instructional material.
- Hydraulic tubes, hose assemblies, fittings etc...
- Hydraulic valves, velocity fuses, filters, manifolds, solenoids, etc...
- Rotation swivel and associated components.
- Waterway including mounting brackets and seals.
- Cable tracks, raceways, and associated components used to guide cables and hoses (igus or similar).
- Rung covers.
- Aerial control valves, switches, levers and joysticks.
- Aerial motion control computing devices (plc or similar).
- Aerial remote control receivers, transmitters, controls pads, tethers, and associated equipment.
- Optional equipment such stokes basket mounts, rope rescue pulleys and anchors, parapet ladders, etc...
- Fall protection anchors.
- Platform basket components including doors, gates, latches, handrails, etc...
- Stepping, standing, and walking surfaces.
- Access ladders and handrails.

Running the Engine

Unless a maintenance routine specifically states otherwise, turn off the engine and all other equipment prior to performing maintenance tasks.

Preparing for Maintenance

Remove all jewelry prior to working on your apparatus. Metal jewelry is a conductor and can cause burns if in contact with electrical power, and other injuries if worn while performing maintenance. Rings can get caught on projections leading to loss of fingers. Hanging jewelry can get caught in moving machinery.

Always use appropriate PPE including gloves, eye protection, hearing protection, safety shoes, and protective headwear when working on your apparatus.

Depressurize air, hydraulic and cooling system lines prior to removing or replacing components.

Ensure working areas are free from oil, grease, and foreign materials.

Compressed Air for Cleaning - DO NOT USE

The use of compressed air for cleaning is not recommended. Using compressed air for removing debris creates an environment of propelled foreign particles, which can cause injury to personnel.

Chemicals and Cleaners

Use only non-flammable solvents for cleaning component parts.

Keep chemicals and cleaners in approved safety containers and in minimum quantities.

Use approved protective equipment and clothing, such as gloves, apron, and eye protection, when handling chemicals and cleaners. Some chemicals have an adverse effect on skin and eyes.

Ensure adequate ventilation when using chemicals and cleaners. Some chemicals have an adverse effect on the respiratory tract.

Observe all manufacturers manuals, warning labels and current safety directives.

Use chemicals and cleaners in authorized areas only.

Dispose of all soiled clothes and materials in accordance with national and local directives for hazardous waste.

Decontamination Chemicals

Decontamination chemicals that contain hydrogen peroxide (such as Decon 7) should be used with caution and strictly following the manufacturer's instructions. Hydrogen peroxide is an oxidizing agent that will cause corrosion when applied to bare metal. It will also damage exposed electronics.

Follow these guidelines:

- Apply in the cab interior as a fine fogging mist only. Do not spray directly on bare or unfinished metal surfaces, or painted surfaces that have been scratched or marred.
- Do not spray or foam on switches, gauges, display screens, or other electrical or electronic devices.
- Remove accidental over-spray using water and a clean cloth.

SAFETY

Always follow the manufacturer's safety recommendations while working with decontamination chemicals including:

- Use only EPA registered products.
- Avoid breathing mist or vapors.
- Wear Gloves (resistant to chemical products [butyl rubber, nitrile and neoprene, polyethylene, polyvinyl chloride]).
- Wear protective clothing.
- Wear eye protection (face shield or safety glasses).
- Wear Respiratory protective equipment (air respirator or SCBA).

Tilting the Cab

Always ensure that the vehicle is on a flat and level surface before tilting the cab. Tilting the cab on an inclined or non-flat surface may produce interference between components as the cab is lowered.

Before tilting cab:

- Check the front bumper and bumper extension to ensure that covers are shut and plumbing swivels are rotated forward. Remove all loose items from the cab as contents may shift or drop.
- Close the crosslay cover and stow any other body related feature that hangs over the cab.
- Raise any aerial device if located over the top of the cab.
- Ensure that there is clearance above the cab and the area is clear of power lines.

Always check to make sure that people working on or around the cab are clear before raising or lowering the cab. Immediately after raising ensure that the stay-arm or mechanical support is secured in the support position. Hydraulic cylinders can leak or drift and should not be relied upon to support the cab on their own.

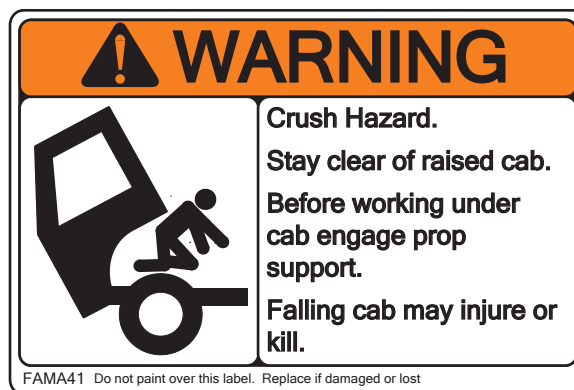

If the cab fails to lower after following the proper instructions, do not attempt to force it. Have the system checked by a qualified technician and refer to the cab tilt system instructions in the service manual.

Lock-Out Tag-Out

You may come across an apparatus in your facility with a sign that says Lock-Out Tag- Out (LOTO) on it, or you may need to perform work where LOTO procedures are required. LOTO is the procedure used for preventing the unexpected release of hazardous energy while servicing and maintenance activities are performed.

Never operate a vehicle or equipment that is marked with LOTO devices. Always use LOTO procedures as required; failing to do so may expose you to hazards associated with hazardous energy sources. Follow your department procedures, which should conform to OSHA 1910.147 regulations.

Access Features Not Provided

Your apparatus may have methods to access equipment or machinery for service or periodic maintenance. These areas may or may not be equipped with a means of access that allows three points of contact at all times. If it is necessary to climb onto, into or around portions of your apparatus that are not equipped for three points of contact, special accommodations must be made for safe access in a controlled, service environment. Use overhead safety harnesses and tethers, step ladders, access platforms, scaffolding or other means to ensure that service and maintenance personnel are protected from stepping, standing and climbing hazards.

Confined Space

Your apparatus may contain spaces such as water tanks that are considered to be “confined” because their configuration hinders the activities of employees who must enter into, work in or exit from them. In certain instances, employees who work in confined spaces also face an increased risk of exposure to serious physical injury from hazards such as entrapment, engulfment and hazardous atmospheric conditions. Confinement itself may pose entrapment hazards, and work in confined spaces may keep employees closer to hazards such as machinery components. Limited access and restricted airflow can result in hazardous conditions that would not normally arise in an open workplace.

OSHA’s standard for confined spaces (29 CFR 1910.146) contains the requirements for practices and procedures to protect employees, in general industries, from the hazards of entering confined spaces. Evaluate your apparatus to determine if there are confined space hazards and take proper precautions before working in a confined space. Use lock-out /tag-out procedures where appropriate.

Welding

Your chassis has high-strength steel frame rails that should not be welded on unless you are following a specific factory authorized repair procedure. Welding on your chassis frame in any manner not prescribed by the factory may result in serious structure failure.

Your apparatus includes electronic components that can be damaged from the high voltage and current generated during the welding process leading to apparatus failure.

Disconnect electronic devices prior to welding on your apparatus including:

- Bosch or WABCO ABS ECU.
- Cummins Engine ECU.
- Allison Transmission Control Module (TCM).
- Foam Pro foam system ECU, pump, and gauge connections.

SAFETY

- Flasher modules.
- Side Roll and Frontal.
- Occupant Protection system ECUs.
- Multiplex system modules.

Do not weld on galvanized frame rails or other galvanized components as serious adverse health reactions may result.

Interlocks

Your apparatus may include protective interlocks that modify or prevent certain functions. These interlocks were designed into your vehicle for your safety and the safety of your operators. Never place an apparatus back in service unless all factory interlocks have been restored to their proper function. Never bypass a safety interlock device.

Batteries

Always wear safety goggles and protective clothing when working on or around batteries. Do not check battery condition by shorting across terminals. Inhaling hydrogen gas produced by the normal operation of the battery could result in partial or permanent damage to the respiratory system. Battery posts, terminals and related accessories contain lead and lead compounds — chemicals known to cause cancer and reproductive harm. Wash hands after handling.

Before servicing batteries on your apparatus, become familiar with safe handling techniques. Batteries give off hydrogen gas that is highly explosive. Keep all sources of ignition away when working around batteries, including matches, lighters, and cigarettes. Sparks caused by connection of battery terminals, jumper cables or charging systems can be a source of ignition. Whenever disconnecting battery terminals, always disconnect the ground terminal first. When reconnecting, always connect the ground terminal last. Do not attempt to jump-start a vehicle having a frozen battery because the battery may rupture or explode. If a frozen battery is suspected, examine all fill vents on the battery. If ice can be seen, do not attempt to start with jumper cables. Thaw out battery before jump-starting or recharging.

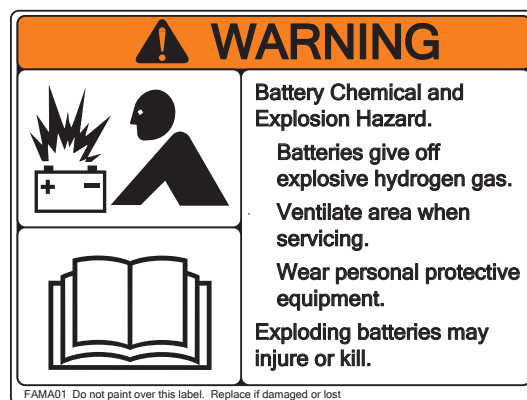

Battery Charging

Never disconnect a battery while charging: this could cause sparks.

Do not use battery charging equipment in the rain, in areas used for washing or in damp areas.

Gases generated during charging are explosive. Do not smoke in the vicinity of the batteries. Use battery chargers only in well ventilated areas.

Before starting to charge, make sure the voltage of the equipment suits the voltage of the battery, that the charging current suits the capacity of the battery and that the selected charging curve (for lead-acid batteries or airtight gel batteries) is correct for the type of battery to be charged. In addition, make sure the rated input voltage of the charger suits the available supply voltage and the system is equipped with grounding.

High Pressure Hydraulic Fluid

Your apparatus develops high pressure fluid in the fuel lines of your engine. You may also have features powered by high pressure hydraulic fluid. If you see or suspect a fluid leak, shut down the equipment and call a service technician trained in safe methods of troubleshooting and servicing high pressure equipment.

Never search for leaks with your hands or other body parts. High pressure fluid can penetrate skin. Use a piece of wood or cardboard to detect leaks, keeping hands and other body parts well away from the potential source of the leak.

If you suspect that you have been exposed to high pressure fluid through skin penetration, seek medical help immediately. The high-pressure injection of a fluid such as fuel, hydraulic oil, grease and paint constitutes a medical and surgical emergency, requiring access to appropriate, surgical specialists as soon as possible. Often, the injury appears minor; don't be fooled. Fluids injected under the skin are highly toxic. The injury will lead to gangrene, amputation or death if not treated promptly.

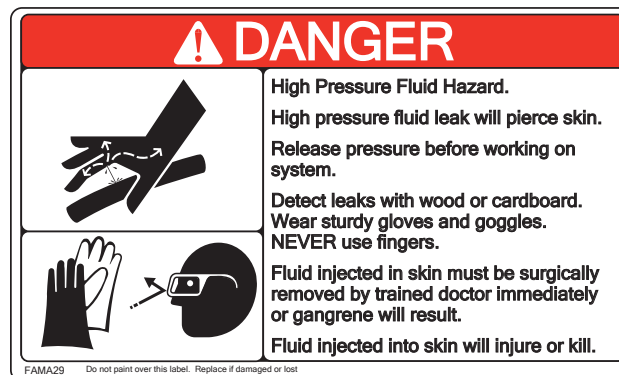

Aerial Device Equipment Mounting

Anything mounted on your aerial device subtracts from the load capacity. Your load chart assumes that you have not mounted any additional equipment or modified the device in any way. Never add any equipment or mounting provisions that add weight to the device without written permission from this manufacturer.

Aerial Device Inspection

Your aerial device is a complex machine that requires constant care and thorough inspection. Study your aerial device's manufacturer's operation and maintenance manuals, the IFSTA Pumping and Aerial Apparatus Driver/Operator Handbook, and the NFPA 1911 Standard for the Inspection, Maintenance, Testing and Retirement of In-Service Automotive Fire Apparatus to determine the critical points on the device that should be regularly inspected. Inspect these points and look for signs of wear, corrosion or impending failure.

SAFETY

Critical points of inspection should include, but not be limited to:

- Pins.
- Cables (Wire Rope).
- Sheaves.
- Lighting.
- Cylinders.
- Wire Insulation.
- Wear Pads and Surfaces.
- Weld Joints.
- Electrical Cabling.
- Mounted Equipment.
- Slip Resistant Surfaces.
- Structural Members.

Follow the NFPA 1911 recommendations for annual inspection.

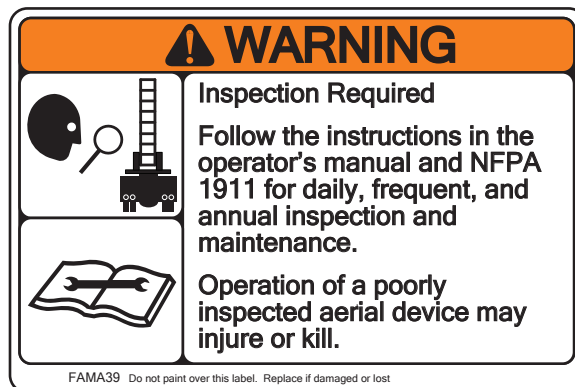

Radiator Cap

The radiator cap serves an important function. It holds the pressure of the cooling system so that coolant flows continuously through the radiator. You may need to remove the radiator cap on occasion to fill the radiator with coolant or to test the cooling system. Before attempting to remove the cap, allow the radiator to cool down completely. The cooling system is both hot and under pressure. At normal operating temperature, the coolant can reach several hundred degrees Fahrenheit, cause serious burns on your skin, or cause you to go blind if it gets into your eyes. To prevent splashing, cover the cap with a rag.

Seat Belt Inspection and Replacement

You should inspect the seat belt components of your apparatus regularly to ensure they will function properly in a crash. Webbing can be abraded, soiled, or torn more quickly in a fire apparatus than in your personal vehicle due to the heavy duty service they will experience. The entire seat belt assembly

should be inspected for corrosion, wear, fraying, or weak spots. The retractor, latch and buckle should be checked for proper function, and all seat belt mounting bolts should be tight at all times.

Seat belt webbing should be considered for replacement at least every five years. Replace seat belts as a complete assembly. Replace any seat belt assembly that is exposed to a serious crash before the vehicle is placed back in service.

Do not bleach or dye seat belt webbing. Bleaching or dying may cause a severe loss of belt strength resulting in failure during a crash.

Inspect the seat belts as follows:

- Webbing should be free from frays, cuts, and excessive wear. Pay attention to the area near the buckle latch plate and in the D-loop guide area.
- Webbing should be clean, and not severely faded from exposure to the sunlight.
- Buckle receiver should slide together easily with a positive click when they latch.
- Sliding Komfort Latch® should operate properly.
- Seat belt retractor should retract the webbing completely with no or minimal assistance.
- All mounting bolts should be tight.

Side Roll or Frontal Crash Occupant Protection

Your apparatus may be equipped with inflatable occupant restraints (air bags), seat belt pretensioners, and suspension seat pull-down devices. These devices operate in a split second and are powered by pyrotechnic (explosive) charges. Never attempt to remove, modify, or repair any of these devices without the express permission and instructions from a factory representative. Tampering with or removing an inflatable occupant protection system sensor (the black box that controls the firing of the devices) can cause the devices to fire which may lead to injury or death. Consult the factory before attempting any removal, modification or repair of any air bag, air bag sensor, seat belt pretensioner, or suspension seat pull-down device.

Pyrotechnic devices can be dangerous if modified or removed. When activated in a crash or rollover they will exhaust harmless blue smoke. Never service, attempt to salvage, or reuse side roll or frontal protection components. Never weld or apply heat on or near side roll or frontal protection components. Never grind, puncture, or drill on side roll or frontal protection.

Information on all component caution and warning labels must be complied with. Labels are placed in visible locations on each component of the Side Roll Protection System. If labels have been removed or are not visible, please contact your customer service representative for the proper replacement labels.

After one of these systems has been deployed, the major components cannot be reused. The Suspension Seat Safety System (S4S), roll & slave sensor(s), Integrated Gas Pretensioners (IGP) / Integrated Belt Pretensioners (IBP), and Inflatable Head Curtains (IHC) / Supplemental Restraint Airbags (SRA) must be replaced. In addition, the wiring harnesses will require inspection and possible replacement. After all system components are inspected and/or replaced, the integrity of the system must be checked by an authorized technician. This service must be performed by a service facility authorized by customer service.

Suspension Seat Tethers

Your apparatus may include a suspension seat that uses a seat tether. Inspect each suspension seat and identify any web-type tether that connects the suspension seat to the cab floor structure. If the tether includes an adjustment feature, ensure that it is adjusted to allow full travel of the seat suspension only. The tether should be taut when the seat is adjusted to its full forward and upward excursion of travel.

Tire Inflation Pressure

Proper tire inflation is vital to the safety and performance of your apparatus and should be checked with an accurate tire pressure gauge only. Never reduce inflation pressure to attain a softer ride. Under-inflation causes excessive flexing within a tire, resulting in heat build-up which can cause a blowout. An under-inflated tire running at highway speeds and under heavy load can cause severe handling problems.

Tire Wear Inspection

Inspect tires for signs of abnormal or excessive wear. Sufficient tread depth is essential to proper handling and braking performance. Refer to the tire manufacturer's manual for minimum tread depth requirements. Replace tires before minimum tread depth is reached.

Tire tread life is dependent on many factors including the following:

- Tire load.
- Brake power.
- Engine horsepower.
- Suspension alignment.
- Proper inflation pressure.
- Frequency of tight cornering maneuvers.
- Driving habits of acceleration and braking.
- Tire footprint (area of rubber in contact with the road).
- Tandem scrub (inherent to all non-steering tandem suspensions).
- Frequency of dry-steer maneuvers (steering the vehicle in the absence of forward motion).

Tire Replacement

Tire rubber degrades over time, even if the tire is not used. Replace your tires after they have been on the apparatus for more than seven years, even if the tread is still satisfactory.



The tires installed on this vehicle at the factory as original equipment are certified for compliance with federal greenhouse gas and fuel efficiency performance regulations. In order to maintain the same level of tire performance, replacement tires must be of equal or lower rolling resistance level (TRRL or CRR). Consult with your tire supplier(s) for appropriate replacement tires.

Manual Parking Brake Release (Caging the Brakes)

If your apparatus must be towed and sufficient air brake pressure is not available, the spring brakes will need to be manually released or “caged.” Remember that caged brakes will not hold your apparatus from rolling. Never leave a vehicle with caged brakes unattended, park it on flat surface only, and chock the wheels in both directions before caging the brakes. Perform lock-out/tag-out to secure the vehicle and make sure no one drives it or removes the wheel chocks until repairs are complete.

Line-Voltage Components and Wiring

Your apparatus may be equipped with a line-voltage generator that produces high 120V, 240V, single or three-phase alternating current. Line voltage generators, components, wiring, and circuit protection should be maintained by qualified and authorized electricians trained in all aspects of the National Electrical Code (NEC) safety practices.

Disconnect power before removing any line voltage breaker box cover or junction box cover or working on line voltage wiring. Follow National Electrical Code safe practices. Electrical shock can injure or kill.

To avoid property damage, personal injury, or death, refer to the component manufacturer’s service information before working on any high voltage equipment. By definition, high voltage circuits and components contain voltage levels that may cause equipment damage, electrical shock and/or electrocution if handled incorrectly.

All electrical circuits associated with Auxiliary Power Units (APUs), shore power, and inverters should be considered high voltage.

Shoreline Electrical Connection

Your apparatus may include an electrical connection to keep the batteries charged while in the station (commonly referred to as a shoreline connection). A compatible power cable is required to make this connection. It is essential that the source of power is the correct electrical phase, polarity, voltage and current capacity. Refer to the placard near the shoreline connection. Only connect the vehicle to a trusted source that you are sure meets these criteria and NEC and local electrical codes.

SAFETY

Wire Rope Inspection or Maintenance

Your apparatus may use wire rope (cable) that needs to be inspected or serviced. Wire rope, through use, can develop “barbs” which can slice skin. It is extremely important to wear protective gloves while handling wire rope. Avoid loose fitting clothes or anything that could become entangled in the wire rope and other moving parts.

Air Conditioning Refrigerant

Use only refrigerants approved for use in air conditioning systems. Some unapproved refrigerants are flammable and can explode, causing injury to personnel. The air conditioning system contains refrigerant under high pressure. To avoid risk of personal injury or damage to the system, only a certified technician should add refrigerant or perform any repair requiring lines to be disconnected.

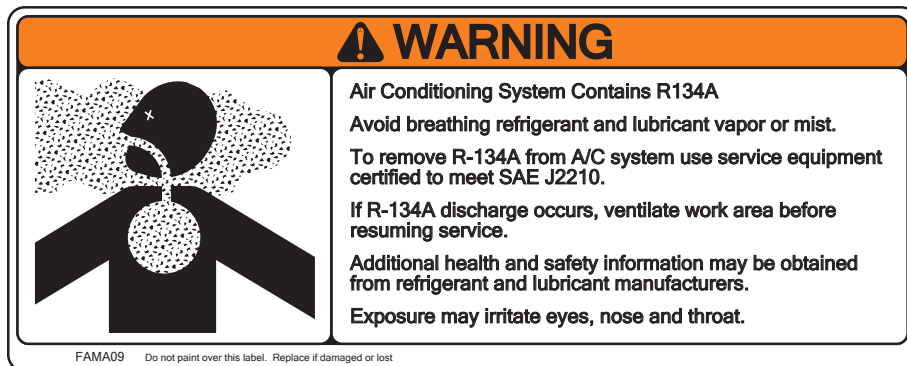

Towing Your Apparatus

Only allow your apparatus to be towed by a trained, authorized, and experienced tow operator. Tow only with a sufficiently capable heavy duty wrecker. To prevent damage, injury or death,

- Do not lift apparatus from front bumper or front bumper extensions.
- Only lift apparatus from front axle, front suspension, or chassis frame rail or frame rail crossmember that is bolted directly to the frame.
- Disconnect the driveline or remove the axle shafts from the drive wheels.
- The wrecker operator is responsible for following all warnings associated with equipment, controls, and operation.

No-Spin or Locking Differentials

If your apparatus is equipped with a No-Spin or Locking Differential be sure to distribute the load evenly side-to-side; do not exceed the vehicle’s rated payload capacity; keep the diameter of the tires equal. Failure to observe these measures can create a difference in individual wheel speeds which can cause the No-Spin or locking differential to deliver power to only one side of the vehicle and thus cause steering problems.

Turn the engine off and raise all driving wheels of a No Spin or locking differential equipped axle when changing tires to prevent the vehicle from moving. Axles equipped with No-Spin or locking differentials deliver power to both wheels - even when only one wheel is on the ground.

CONTROL DESCRIPTIONS

OVERVIEW

This section of the Operator's Manual describes the controls you will need to be familiar with to safely and properly operate your aerial device. The Operating Procedures Section of this manual will go on to explain how to use these controls for safe and proper operations. As fire apparatus are by nature customized to the needs of particular departments, your aerial apparatus controls may have certain variations from the descriptions in this section. If you need assistance or further explanation, contact your department safety or training officer.

MAJOR COMPONENT DESCRIPTION

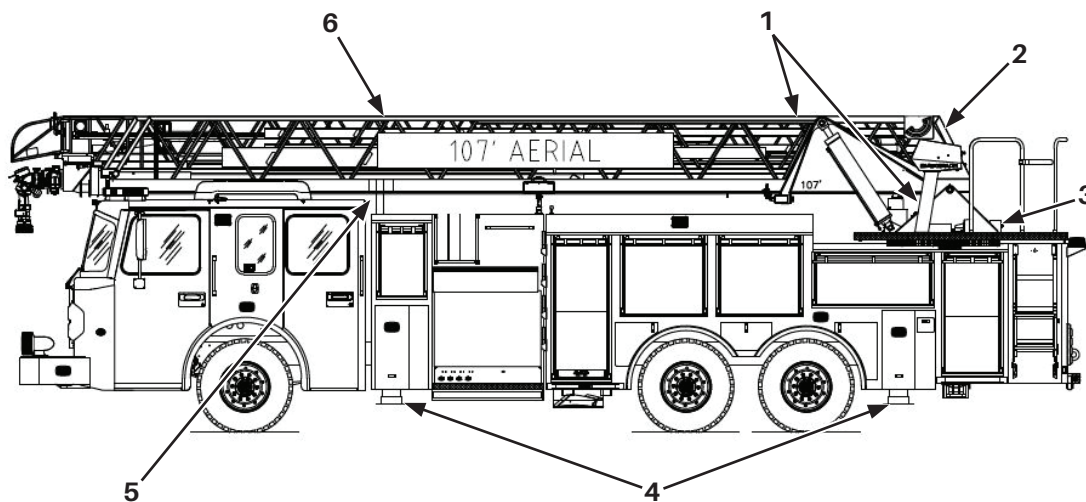

Figure 3-1. Major Component Descriptions

1. **Aerial Ladder** - An aerial device consisting of the turntable, ladder, stabilizers and all associated equipment.
2. **Primary Operator Station** - Control station on the device turntable from where the aerial ladder is operated.
3. **Turntable** - That part of the aerial ladder that is attached to the vehicle and provides rotation of the aerial ladder through 360 degrees. The primary operator control station is located here.
4. **Stabilizer** - A system designed to transfer the weight of the apparatus from the tires and suspension to a solid structure consisting of horizontally extending beams and vertical jacks.
5. **Ladder Cradle** - Supports the aerial ladder when the device is stowed.
6. **Ladder** - That part of the aerial ladder that is attached to the turntable and provides the ability to extend, retract, and elevate. The ladder is composed of two or more sections. (A four-section ladder has a base section, lower-middle section, upper middle section, and a fly section.) The ladder structure provides integral climbing rungs and handrails.

CONTROL DESCRIPTIONS

AERIAL RELATED CONTROLS IN THE CAB



Figure 3-2. Cab Controls

1. **Parking Brake** - Engages the service brakes on either the rear axles, or all the axles (optional), when activated.
2. **Transmission Selector** - Controls transmission gear selection.
3. **High Idle** - Raises engine speed to optimal rpm for aerial operation. Will not engage if fire service pump is engaged. This overrides the automatic high idle feature on the Aerial Device controls.
4. **Stabilizer Obstruction Indicator (Optional)** - Provides a visual indication of the extension of the stabilizer beams if there are obstructions near the apparatus. Green indicates full extension. Orange indicates partial extension with a lower tip load. Red indicates a short set with no operation on that side of the apparatus.
5. **Aerial Master** - Engages electrical power to the aerial device control systems.
6. **PTO** - Engages the PTO drive to the aerial hydraulic pump. (May also drive the generator hydraulic pump.) If your apparatus is equipped with a single Aerial Master/PTO switch, where this manual references individual switches, utilize the single switch.

STABILIZER CONTROLS

Stabilizer Control Panel

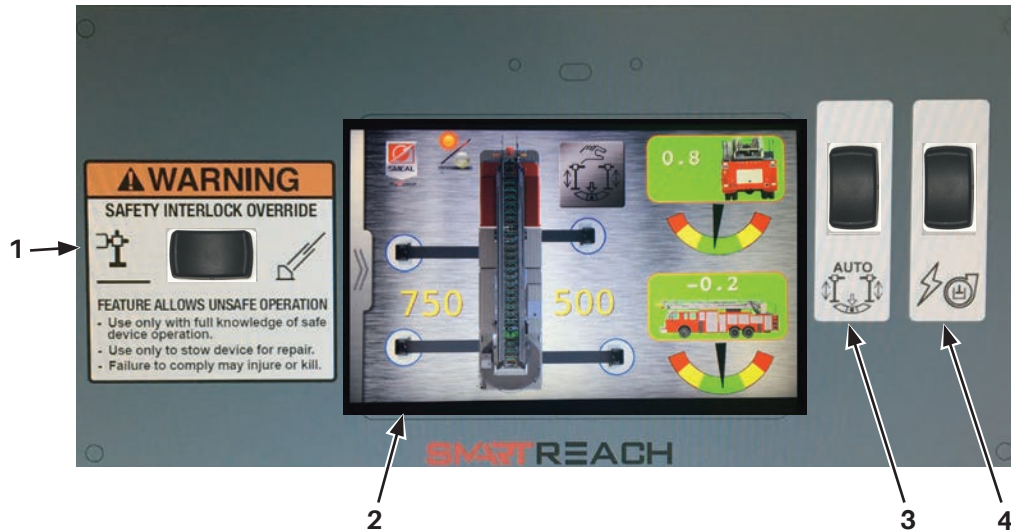

Figure 3-3. Stabilizer Control Panel

1. **Safety Interlock Override** - Three position momentary switch that overrides the Ladder or Stabilizer Interlock.
2. **Stabilizer Information Display** - Provides multiple screens with information such as the leveling range and tip loads based on stabilizer deployment, hydraulic system status, etc.
3. **Auto Level** - Momentary switch to activate and de-activate the auto leveling feature.
4. **EPU Switch** - Momentary switch that engages the electrical auxiliary hydraulic back-up pump.

Stabilizer Information Display

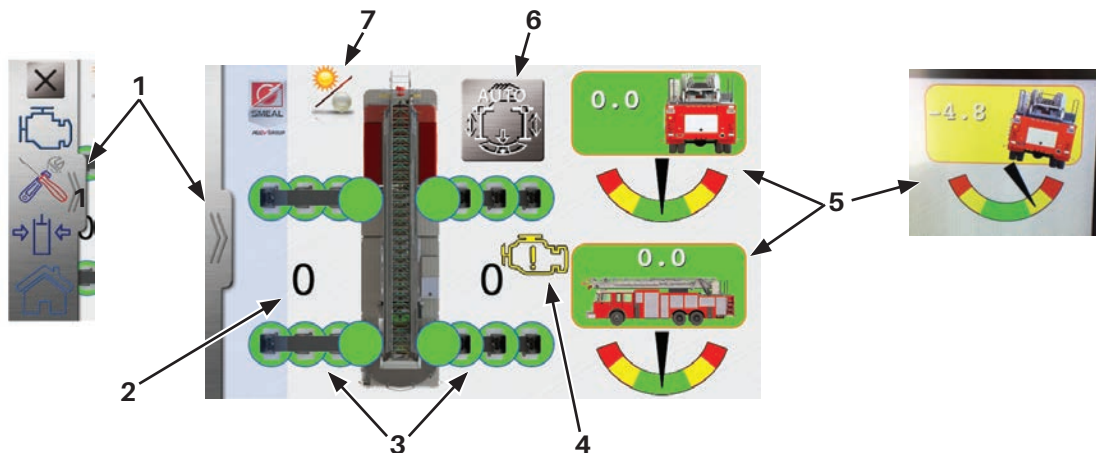

Figure 3-4. Stabilizer Information Screen

CONTROL DESCRIPTIONS

1. **Stabilizer Menu Icon** - Icon is used to access other information screens. These include Engine Information, Service Menu's, and Hydraulics Screen.
2. **Tip Load Indication** - The number indicates the tip load of the aerial device on that side of the apparatus. Either 750 (340 kg), 500 (227 kg), 250 (113 kg), or 0.
3. **Stabilizer Icons** - Indicates extension of the beam shown with a black line and the plant of the jack shown with a green circle.
4. **Engine Information** - Icon is displayed when there is a warning condition present on the engine.
5. **Level Indicators** - The level indicators assist the operator in setting up the apparatus as level as possible and to provide the load limit based on apparatus leveling. If the apparatus is in the yellow range the background of the apparatus image turns yellow.

Gravity Bubble level indicators (Not shown) are also provided. One is positioned near the stabilizer control station for side to side indication. The other is located in the turntable access ladder area for front to back indication.

6. **Auto Level** - Touching the icon activates and de-activates the auto leveling feature.
7. **Day/Night Mode** - Changes the background of the display to a less intense light for dark conditions.

Hydraulic Screen

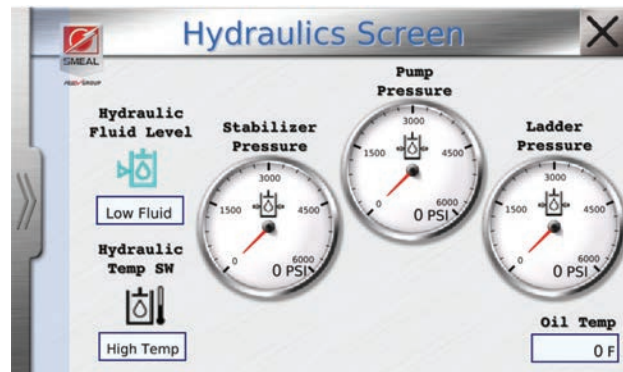

Figure 3-5. Hydraulic System Information Screen

1. **Hydraulic Fluid Level** - Status will be displayed in the text box, OK or Low.
2. **Hydraulic Temp** - Hydraulic pump temperature status will be displayed in the text box, OK or High.
3. **Below (Stabilizer) Pressure** - Hydraulic pressure in the stabilizer section of the device control system after the diverter valve.
4. **Pump Pressure** - Hydraulic system pressure measured after the pump outlet.
5. **Ladder Pressure** - Hydraulic pressure in the ladder section of the control system after the diverter valve.
6. **Oil Temp** - Displays the actual temperature of the hydraulic oil.

Engine Information Screen

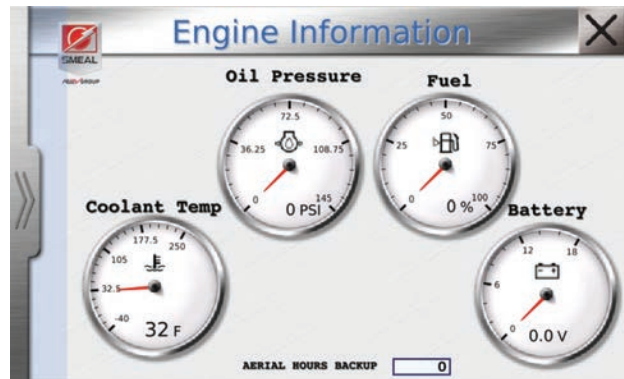

Figure 3-6. Engine Information Screen

Engine Information Screen displays the gauges for Engine Coolant Temperature, Oil Pressure, Fuel Level and Battery Voltage.

Stabilizer Controls

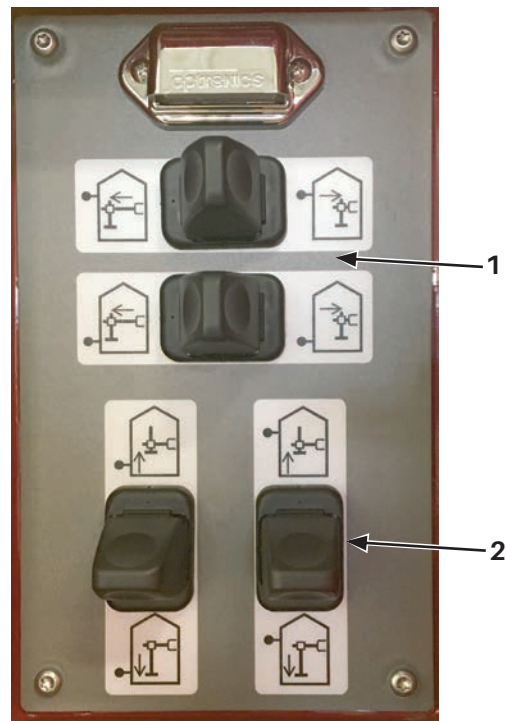

Figure 3-7. Stabilizer Controls - 4 Beams and 4 Jacks

1. **Stabilizer Beam Control** - Extend/Retract control for stabilizer beams.
2. **Stabilizer Jack Control** - Raise/Lower control for stabilizer jacks.

CONTROL DESCRIPTIONS

NOTICE

Apparatus equipped with 2 beams and 4 jacks or 2 beams and 2 jacks will have a control for each beam and jack.

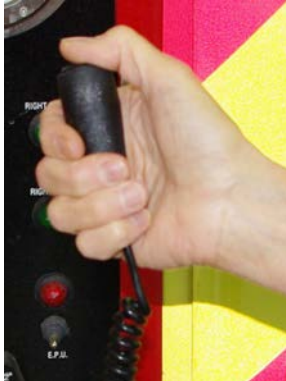

Figure 3-8. Auto Level Actuation Button

3. **Auto Level Actuation Button** (If Equipped) - For operation of the Auto Level feature.

AERIAL LADDER CONTROLS

Primary Operator Control Station

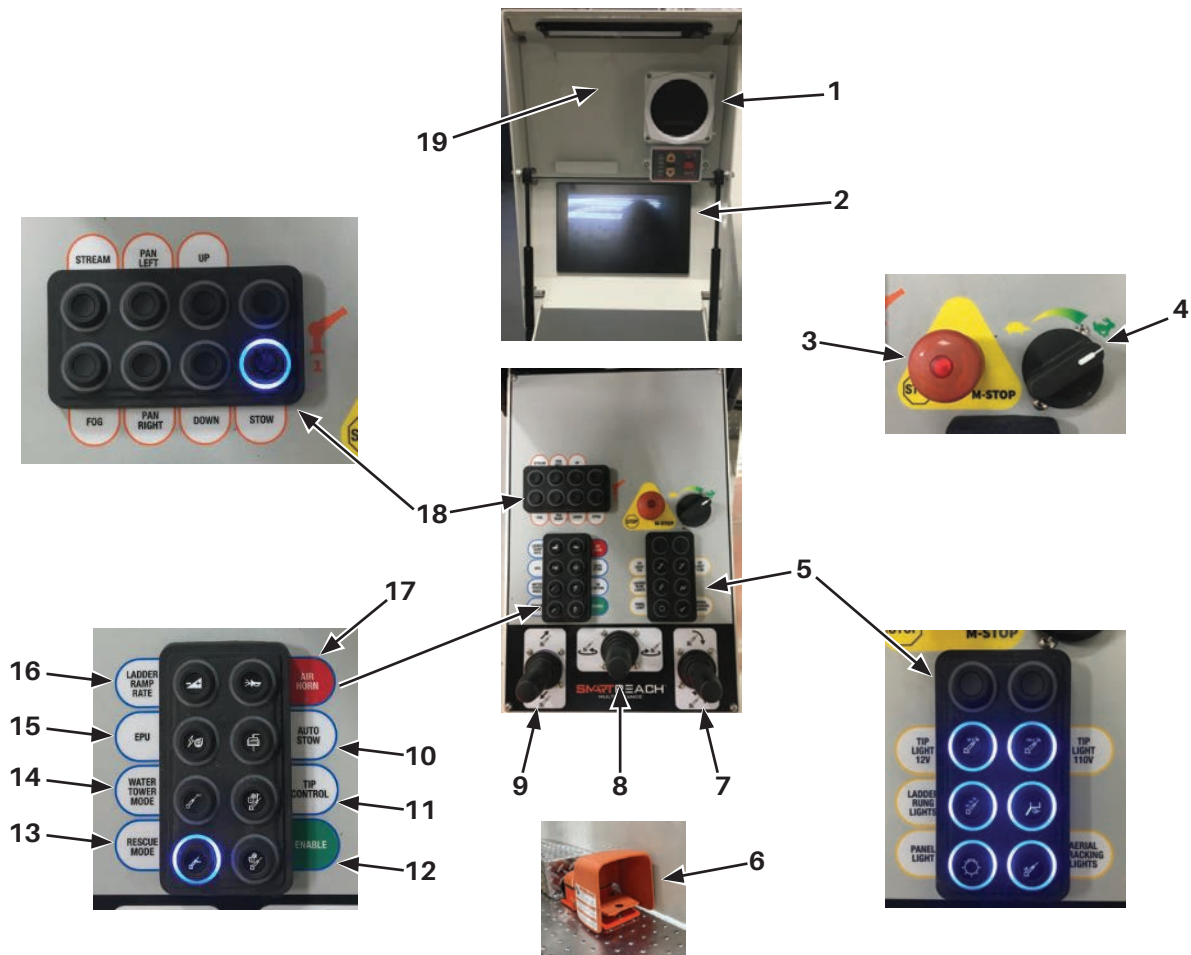

Figure 3-9. Primary Operator Control Station

1. **Communication System** - Consists of either a communication speaker with a push to talk button or a jack where the department can plug in various makes of headsets.
2. **Smart Reach Aerial Display** - Multiple screens provide aerial device information, various load charts and tip load ratings based on the stabilizer deployment and aerial device position.
3. **M-Stop (Machine Stop)** - A red push/twist to unlock style button that activates hydraulic system functions of the aerial device. When the button is twisted and pops up, it illuminates indicating the system is unlocked. When the button is pushed down and locks in, the system is locked and no ladder movement can take place.
4. **Ladder Movement Speed Control** - Controls the maximum speed of the ladder movements. Turn clockwise to increase speed to maximum. Turn counter clockwise to decrease speed to minimum.

CONTROL DESCRIPTIONS

5. **Ladder Lighting Controls** - Momentary push buttons to turn on and off aerial lighting features.

Ladder Rung Lights - Operates the rung illumination lights.

Aerial Tracking Lights - Operates both spotlights on the turntable end of the base section.

Tip Light 12V - Operates low voltage spotlights on the tip of the fly section.

Tip Light 110V (Optional) - Operates high voltage flood lights on the aerial device.

Panel Light - Illuminates the light on the control panel for added visibility.

Open Buttons - Available for optional uses.

NOTICE

Buttons illuminate when the feature is active.

6. **Operator Present Foot Switch** - Ladder controls are enabled when your foot depresses the switch.
7. **Aerial Elevation Control** - Raises and lowers the angle of the ladder.
8. **Aerial Rotation Control** - Controls infinite right (Clockwise) and left (Counter Clockwise) rotation of the turntable.
9. **Aerial Extension Control** - Controls extension and retraction of the aerial ladder sections.
10. **Auto Stowing (Optional)** - Push and hold button to active automatic stowing of the aerial device into the cradle.
11. **Tip Control** - When activated, allows ladder control from the tip of the ladder fly section.
12. **Enable** - Aerial device slows and stops when rotating into a lower tip load zone. Activating this button allows rotation into the lower tip load zone.
13. **Rescue Mode** - Momentary button changes the position of the master stream device from the tip of the fly section of the ladder to the end of the mid or upper-mid section of the ladder.
14. **Water Tower Mode** - Momentary button changes the position of the master stream device from the end of the mid or upper-mid section of the ladder to the tip of the fly section of the ladder.
15. **Emergency Power Unit (EPU) Button & Indicator Light** - A momentary button that activates the back-up emergency hydraulic pump. Light around the button illuminates when the EPU button is engaged and the emergency pump is operating.
16. **Ladder Ramp Rate** - A momentary button that changes the amount of ramping of the ladder when controls are releases. Slow provides maximum ramp, Normal provides medium ramp, Fast provides minimum ramp. Ramp Rate status is shown of the Smart Reach Aerial Display.
17. **Air Horn Control** - Activate the fire apparatus air horn.
18. **Monitor & Nozzle Control (Optional)** - A single momentary button controls each function of the aerial monitor - elevation (raise/lower), sweep (left/right) and pattern (Fog/Straight). The **Stow** button activates the automatic stow feature. When the monitor is in the correct stow position the blue indicator ring is on.
19. **Static Load Chart Display Area** - Magnets are provided in the area to hold the appropriate Static Load Chart for display, if necessary.

20. **Flowminder Display (Optional Not Shown)** - Shows the waterflow through the waterway system in gallons or liters per minute.
21. **Incline Meter** - Indicates the angle of the ladder relative to the earth.



Figure 3-10. Incline Meter

22. **Extension Indicator** - Hash marks at 5 ft. (1.524 M) increments that provide the extension of the ladder tip, in feet, to the center of the turntable.



Figure 3-11. Extension Indicator Marks

OEM Master Stream Remote Control - (Optional)

The remote control for the aerial master stream device is provided by the manufacturer of the monitor. Refer to the manual provided by the monitor manufacturer for operation and maintenance.

CONTROL DESCRIPTIONS

Smart Reach Aerial Display

Smart Reach Multi-Stance™ Load Chart Screen

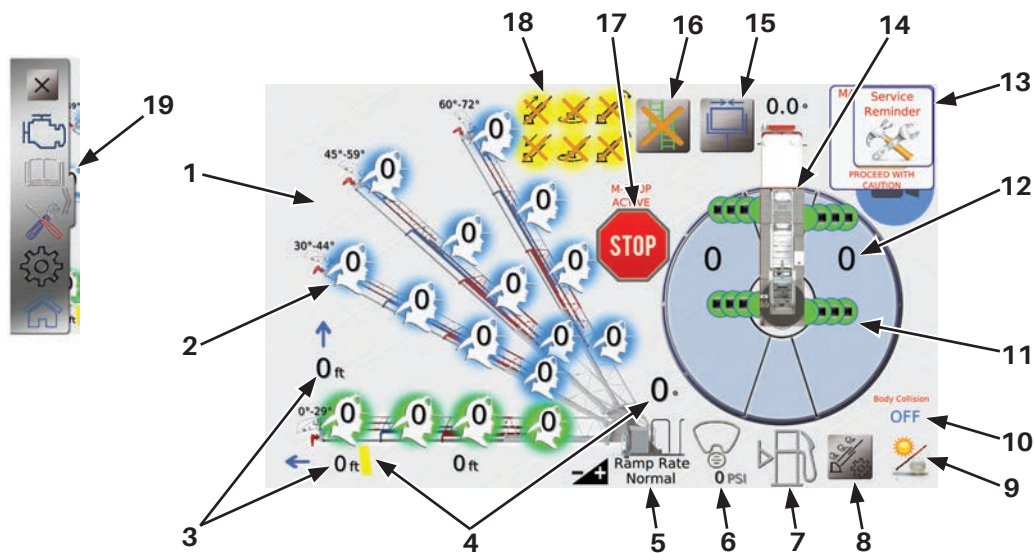

Figure 3-12. Smart Reach Multi-Stance™ Load Chart Screen

1. **Load Chart** - Displays the various load ratings for your aerial ladder based on the extension of outrigger beams, out of level condition of the apparatus, the elevation of the ladder, and the rotational position of the ladder.
2. **Firefighter Head Icon** - A firefighter head icon indicates a load of 250 lbs. (113.4 kg) multiplied by the number in the icon on that section of the ladder.
3. **Elevation & Extension Measurement** - Numbers by the arrows provide extension and elevation of the tip of the ladder.
4. **Elevation Angle** - Yellow arc shows elevation angle of the ladder. The number shows the degrees of elevation.
5. **Ramp Rate** - Indicates the Ramp Rate setting. Slow, Normal, or Fast.
6. **Pressure Indicator (Optional)** - Shows pressure in the breathing air system, if equipped.
7. **Fuel Level** - Icon displays if the apparatus Low Fuel Alarm activates.
8. **Advanced Rung Lighting (Optional)** - Touch this icon to go to the Advanced Rung Lighting Control Screen.
9. **Day/Night Mode** - Changes the background of the display to a less intense light for dark conditions.
10. **Body Collision** - Touch this icon to turn On or Off the Body Collision Avoidance system.
11. **Stabilizer Extension and Plant Indicator** - The Black line shows the extension of each stabilizer beam. The circle appears when the Jack is in contact with the ground and has load on it.
12. **Tip Load** - Number provides the tip load for that area of rotation.
13. **Information Tabs** - Provides information to the operator.

14. **Ladder Rotational Position** - As the ladder rotates, the ladder icon on the screen rotates to show position and tip load. The number indicates the degrees of rotation relative to the cab.
15. **Cradle Aligned** - This icon is displayed when the ladder is in alignment with the cradle. The ladder is not aligned with the cradle when the X covers the icon. May also show the X as a result of the Monitor not being stowed.
16. **Rungs Aligned** - This icon displays when the rungs are aligned for climbing the ladder. The rungs are not aligned for climbing when the X covers the icon. Extend the ladder until the X goes away.
17. **M Stop** - This indicator is displayed when the M Stop has been depressed and the ladder control system is locked out.
18. **Ladder Movement Symbols** - These indicators show the different movements the ladder is capable of making. When an X covers the icon, that function is disabled.
19. **Ladder Menu Icon** - Icon is used to access other information screens. These include Engine Information, Service Menu's, and Settings Screens.

Advanced Rung Lighting Screen (Optional)



Figure 3-13. Advanced Rung Lighting Menu Screen

The Advanced Rung Lighting system provides you with the choice of lighting color and patterns on the ladder. Touch the color on the circle to choose the light color. Select one of the lighting pattern program icons by touching the icon.

When one of the advanced lighting patterns is selected the ladder must not be in motion. If one of the ladder controls is activated the rung lighting will revert to a solid light, in the color that was last selected on the circle.

CONTROL DESCRIPTIONS

Aerial Controls I/O & Trouble Shooting Menu



Figure 3-14. Aerial Controls Trouble Shooting Menu

This menu provides access the various troubleshooting and programming screens within the Smart Reach System. Certain screens require an access code to open. Only qualified technicians should access these screens.

Hydraulic System Information Screen

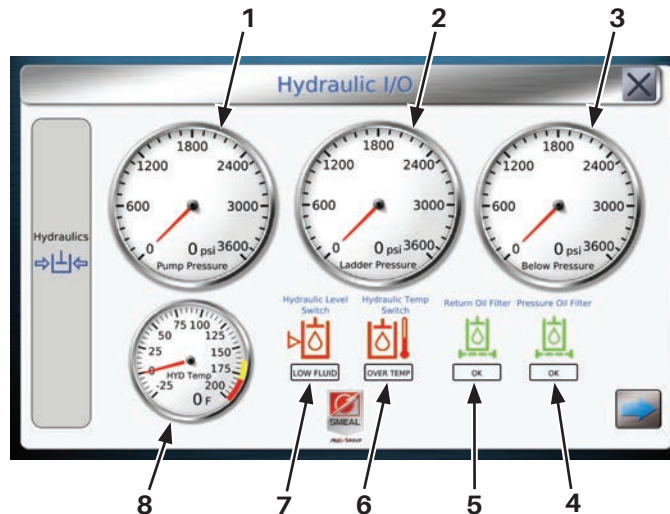

Figure 3-15. Hydraulic I/O Screen

1. **Pump Pressure** - Hydraulic system pressure measured after the pump outlet.
2. **Ladder Pressure** - Hydraulic pressure in the ladder section of the control system after the diverter valve.
3. **Below (Stabilizer) Pressure** - Hydraulic pressure in the stabilizer section of the device control system after the diverter valve.
4. **Pressure Oil Filter** - Displays the condition of the high pressure hydraulic oil filter.
5. **Return Oil Filter** - Displays the condition of the return hydraulic oil filter.

6. **Over Temp** – Provides a visual alarm if the hydraulic oil is overheated.
7. **Low Fluid** – Provides an indication of the level of the hydraulic fluid.
8. **HYD Temp** – Displays the actual temperature of the hydraulic oil.

Aerial Maintenance Screen

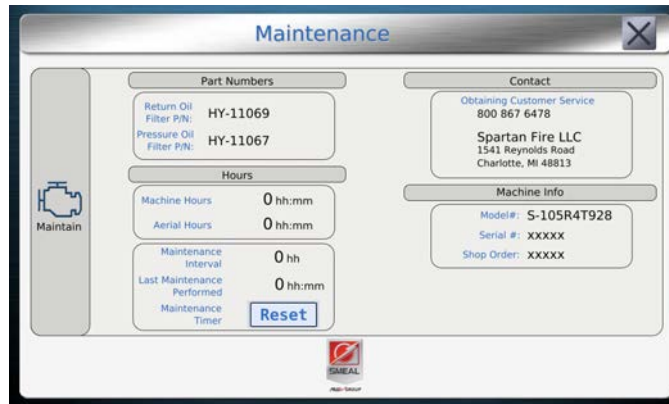

Figure 3-16. Aerial Maintenance Screen

This screen provides information on the aerial ladder, operating hours of the aerial ladder, and when scheduled service should take place. At the completion of scheduled service, touch the Reset icon to start the Maintenance Timer for the next scheduled service.

CONTROLS AT THE TIP OF THE LADDER

Ladder Tip Controls – Electric over hydraulic controls, when activated, move the ladder in all directions. Ladder movement is limited to 10% of full speed.



Figure 3-17. Ladder Tip Controls

Monitor & Nozzle Control – A single momentary button controls each function of the aerial monitor – elevation (raise/lower), sweep (left/right) and pattern (Fog/Straight). The **Stow** button activates the automatic stow feature. When the monitor is in the correct stow position the blue indicator ring is on.

CONTROL DESCRIPTIONS



Figure 3-18. Monitor and Nozzle Control

OTHER CONTROLS & SYSTEMS

Body Collision Avoidance

The ladder is equipped with a system intended to reduce the risk of accidentally striking the apparatus body with the ladder. This system is a pre-programmed envelope that stops ladder movement prior to the ladder striking the body or other fixed devices attached to the body. This envelope is programmed with all movable objects and devices in the stowed/road ready position. Conditions such as the cab being tilted, telescope lights extended, etc, are not part of the collision avoidance programming. The operator must be aware of the position of all of these devices to avoid striking them.



Figure 3-19. Ladder Movement Stops Prior to Contacting Body of Apparatus

Breathing Air System

This system consists of:

- High Pressure Cylinders: One or more large, high-pressure compressed air cylinders certified for breathing air. These are mounted on the outside of the bed section of the ladder.



Figure 3-20. Breathing Air System High-Pressure Cylinder

- Regulators and adapters: Provided to allow for the distribution of air and the refilling of the cylinder(s).



Figure 3-21. Breathing Air System Gauges

- Connections: Quick connect outlets of the type compatible with, and located as required by, the purchasing department are provided.
- Airminder: A pressure monitoring system is provided that shows air pressure in the breathing air system and provides a visual and audible warning at the primary operator control station when the system is low.

Aerial Waterway

An Aerial Inlet is provided at the rear, or side, of the apparatus. Standard configuration does not provide a control valve on this intake, control of flow and pressure is provided by the apparatus supplying the water.

Aerial ladders equipped with a fire service pump will have a control valve, pressure gauge and flow meter at the pump operators panel to control water flow to the waterway.

CONTROL DESCRIPTIONS

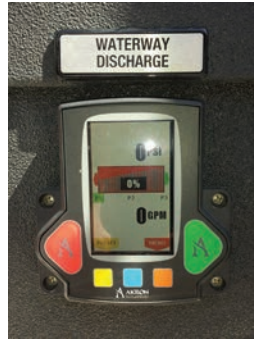

Electronic



Manual

Figure 3-22. Waterway Controls - Electronic and Manual Valve

Waterway Drain: There is a waterway drain valve located adjacent to the Aerial Inlet. On aerial apparatus equipped with a fire pump, there is an additional drain valve located on the pump operator panel.



When supplying water from the onboard pump, water pressure will be present at the Aerial Inlet cap
DO NOT remove this cap when supplying water from the onboard pump.



Figure 3-23. Waterway Drain and Aerial Inlet

OPERATING PROCEDURES

Overview



Read and follow the instructions found in the **Safety Section** of this manual before operating.

The procedures contained in this section of the Operator's Manual explain how to safely and properly operate your Aerial Ladder. Any deviation from these procedures increases the risk of an accident occurring. Accidents may result in damage to the apparatus, as well as injury or death to firefighters and other people using this Aerial Ladder.

Understanding Multi-Stance™

Multi-Stance Variable Ladder Loading

The Multi-Stance System provides various load ratings for your aerial ladder based on the extension of stabilizer beams, out of level condition of the apparatus, the elevation of the ladder, and the rotational position of the ladder. Multi-Stance provides you the option to partially extend one or more stabilizer beams while maintaining the full reach capability of the aerial ladder. Multi-Stance determines the stabilizer setup and monitors the aerial position, then displays the allowable loads that may be placed on each section of the ladder for that set up condition.



When the vertical number is visible, it indicates the allowable tip load. Reference the appropriate Static Load Chart for operational limits.

Figure 4-1. Stabilize Beam - Tip Load Zone Indicators

OPERATING PROCEDURES

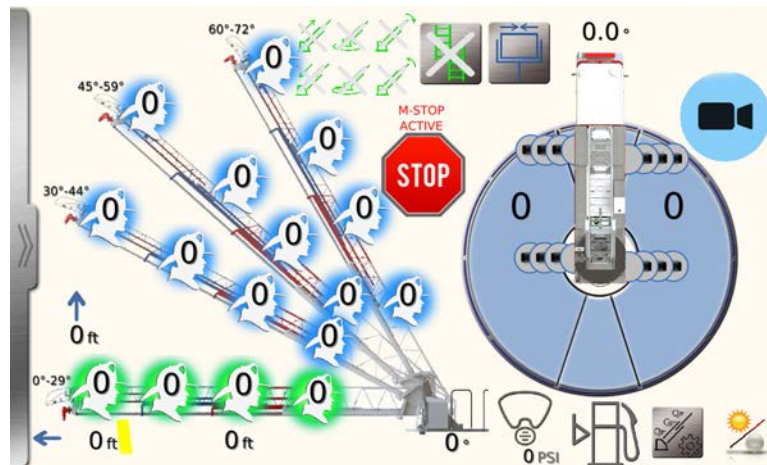

Figure 4-2. Aerial Screen

Multi-Stance provides the ladder's load by monitoring sensors that;

1. Determine the stabilizer beam extension. (750 lb (340.2 kg), 500 lb (226.8 kg), 250 lb (113.4 kg) or No operation).
 2. Determine level zone in which the apparatus is set up. (Green - 100%, Yellow - 50%, or Red - NO Operation).
 3. Determine the rotational position of the ladder.
 4. Determine the elevation of the ladder.
 5. The tip load is displayed on the rotation position indicator on the right side of the load chart screen.
 6. The tip and distributed loads are also displayed on the ladder depiction located on the left side of the load chart screen.
- The firefighter head icons represent a 250 pound (113.4kg) load (The NFPA prescribed weight of an average firefighter in PPE). The number inside the firefighter head icon indicates a load of 250 pounds (113.4kg) multiplied by number in the icon. For example, a firefighter head icon with the number 2 indicates a total of $250 \times 2 = 500$ pound.

NOTICE

For any load that is between a 250 lb (113.4 kg) increment, Multi-Stance will round down to the next lowest increment. If the calculated load is 350 lb (158.8 kg), Multi-Stance will indicate 250 lb (113.4 kg).

- As the ladder elevation changes the number inside the firefighter head icons change. The firefighter head icon in green indicates the allowable load on the ladder in its current configuration. The icons in blue are provided for planning purposes.

- If you set up the stabilizers with the beams at different extensions, the allowable loads on the ladder will change as the ladder passes from one side to the other. As the ladder passes across the centerline of the apparatus toward a lower load condition, the rotation speed will slow and stop. The display will show a warning that the allowable load is about to be reduced. Pressing the **Enable** button will allow the ladder to resume rotation into the lower load range.

Static Load Charts

Static load charts for each load zone are provided for training and emergency backup purposes.

- These charts are stored in a "mail slot" below the primary operator control station. Make certain the keeper is in place for travel.
- The operator must determine which load chart matches the stabilizer beam extension on the working side of the apparatus and the leveling zone indicated on the Gravity Level Indicators.
- A yellow zone load chart is on the back of each Static Load Chart. Mount the appropriate load chart next to the communication control in the lid.

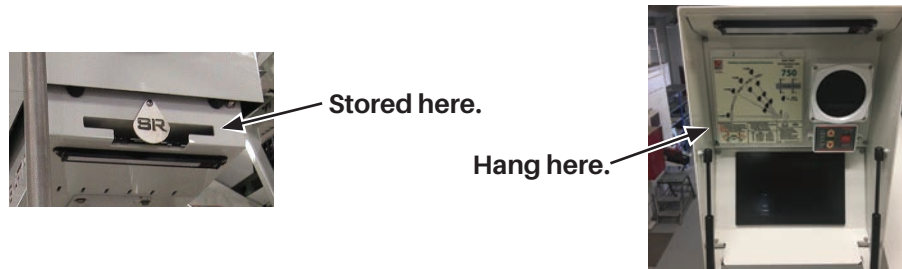

Figure 4-3. Static Load Chart Storage and Mounting Locations

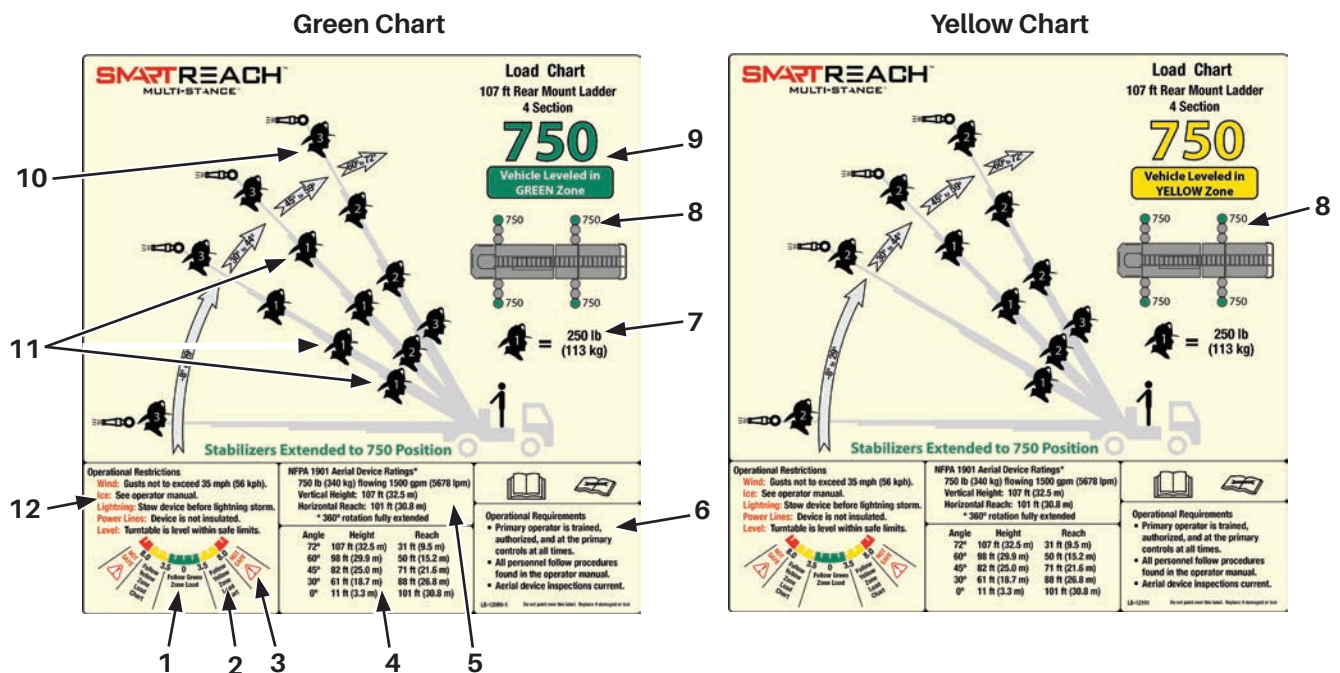

Figure 4-4. 750 lb. (340.2 kg) Static Load Charts

OPERATING PROCEDURES



Overloading the aerial ladder may result in apparatus damage, injury or death.

Level Indicators

There are level indicators on the apparatus body. One Level Indicator shows side to side level and the other Level Indicator shows front to back level. There are three color coded zones indicated. These zones may vary depending upon aerial device model. Always reference the load chart on your aerial device.

1. **Green Zone (0 - 3.5°)** - indicates the aerial device can be loaded to 100% capacity.
2. **Yellow Zone (3.6- 8.0°)** - indicates the aerial device can be loaded to 50% capacity.
3. **Red Zone (Over 8.0°)** - indicates that the aerial device should not be used.

Angle, Height, and Reach Chart

4. This chart is for reference only, to be used to lay out the best location for your device during training or planning exercises. In an emergency you will not have time to measure out the scene, so you must develop good judgment through practice and experience.
 - The Angle column is the degrees the Aerial Ladder is above horizontal.
 - The Height column is the distance from the ground to the top rung of the Aerial Ladder at the corresponding angle, when the Aerial Ladder is at full extension.
 - The Reach column is the horizontal distance from the center of the Turntable to a vertical line from the top rung of the Aerial Ladder, with the Aerial Ladder at the corresponding height.

NFPA 1901 Aerial Device Ratings

5. This list provides the height, reach, load, and water flow capability as determined per NFPA 1901 standards.

Operational Requirements

6. Lists several requirements for Operators before and during aerial device operation.

Aerial Device Loading

7. **Firefighter Head Icon** - Indicates a 250 pound (113.4 kg) load. A firefighter head icon with a number indicates a load of 250 pounds (113.4 kg) multiplied by the number in the icon.
8. **Outrigger Beam Extension and Ladder Load** - The circle that is filled along with the number adjacent to it indicates the fly section load, and the load chart to reference. If the beams on a side of the apparatus are at different extensions, USE the Lower Indicated Load Rating for operations on that side.



Overloading the aerial ladder may result in apparatus damage, injury or death.

9. Load rating for the load chart.
10. This icon indicates the maximum load that can be carried on the fly section of the ladder while flowing water at the rate shown in Aerial Device Ratings (#5), when the apparatus is leveled in the Green Zone (#1). The load must be reduced when the apparatus is leveled in the Yellow Zone (#2). Reduce the load by 250 pounds (113.4 kg) when operating the monitor in the extended range.
11. **Distributed Loads on the Ladder Sections** - As the elevation increases from 0 degrees, additional load can be distributed on the lower sections of the ladder. These icons indicate the maximum load on a ladder section, when the apparatus is leveled in the Green Zone (#1). The load must be reduced when the apparatus is leveled in the Yellow Zone (#2). See the Smart Reach Multi-Stance™ display or the appropriate Static Load Chart for allowable loads in the yellow zone.

NOTICE

If the Load Chart shows an odd number of personnel allowed, then you must always round down to the nearest whole number of people. For example, if the capacity in the green zone is 3 people, then in the yellow zone half of 3.0 people would be 1.5 people. Since you can't have half a person, you must round down to 1.0 people.

Aerial Ladder Capacity in Red Zone (3): After leveling the apparatus, if either Level Indicator is in the **Red Zone** DO NOT use the Aerial Ladder.

NOTICE

Always reference the Smart Reach Multi-Stance™ display or the appropriate Static Load Chart provided with your aerial ladder for specific allowable loads. These can be found at the PRIMARY OPERATOR CONTROL STATION on the turntable. Optional equipment and department specific requirements may affect the rated capacity of your aerial ladder compared with the load chart.

Operational Restrictions

12. Lists conditions that may impact the loading or operation of the aerial device.

Factors that Reduce Live Load Capacity

The load capacity of your aerial ladder is based on standard conditions. As the aerial operator, you are responsible for taking into account environmental factors or other non-standard conditions. Such factors or conditions may include:

- Wind
- Snow
- Ice
- Water Monitor Operation
- Hose and Other Added Equipment

OPERATING PROCEDURES

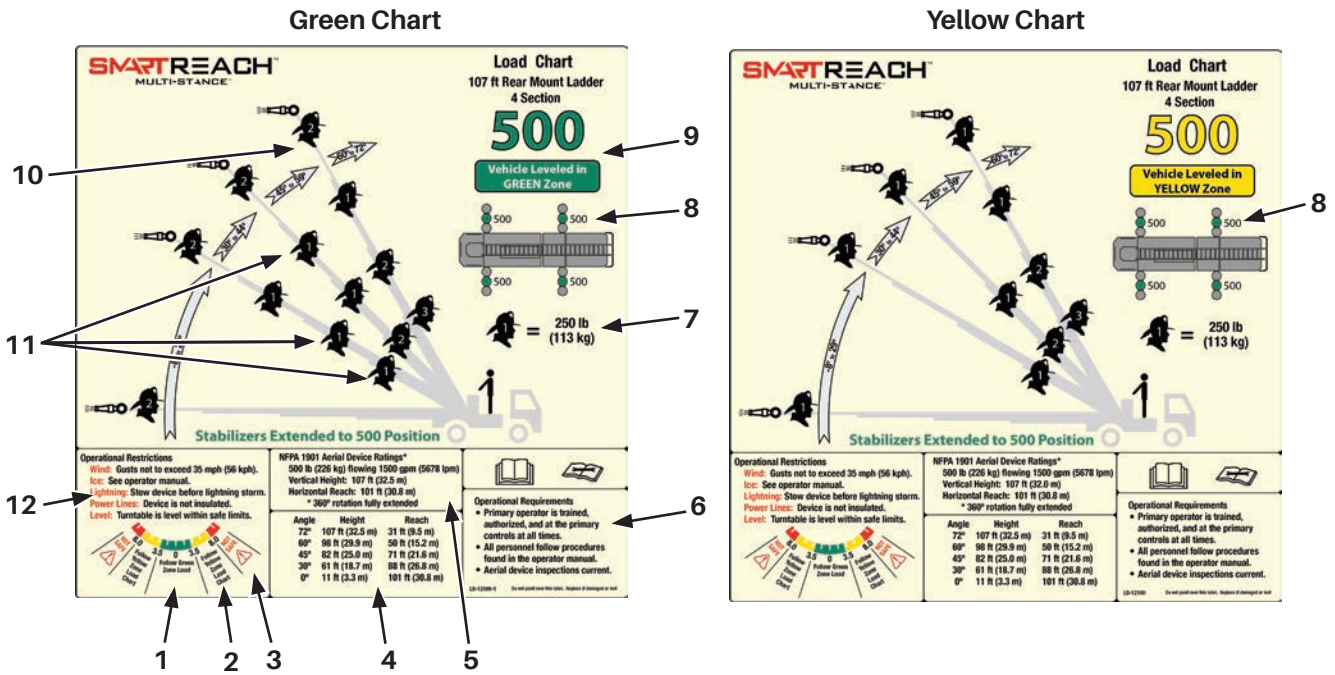

Figure 4-5. 500 lb. (226.8 kg) Static Load Charts

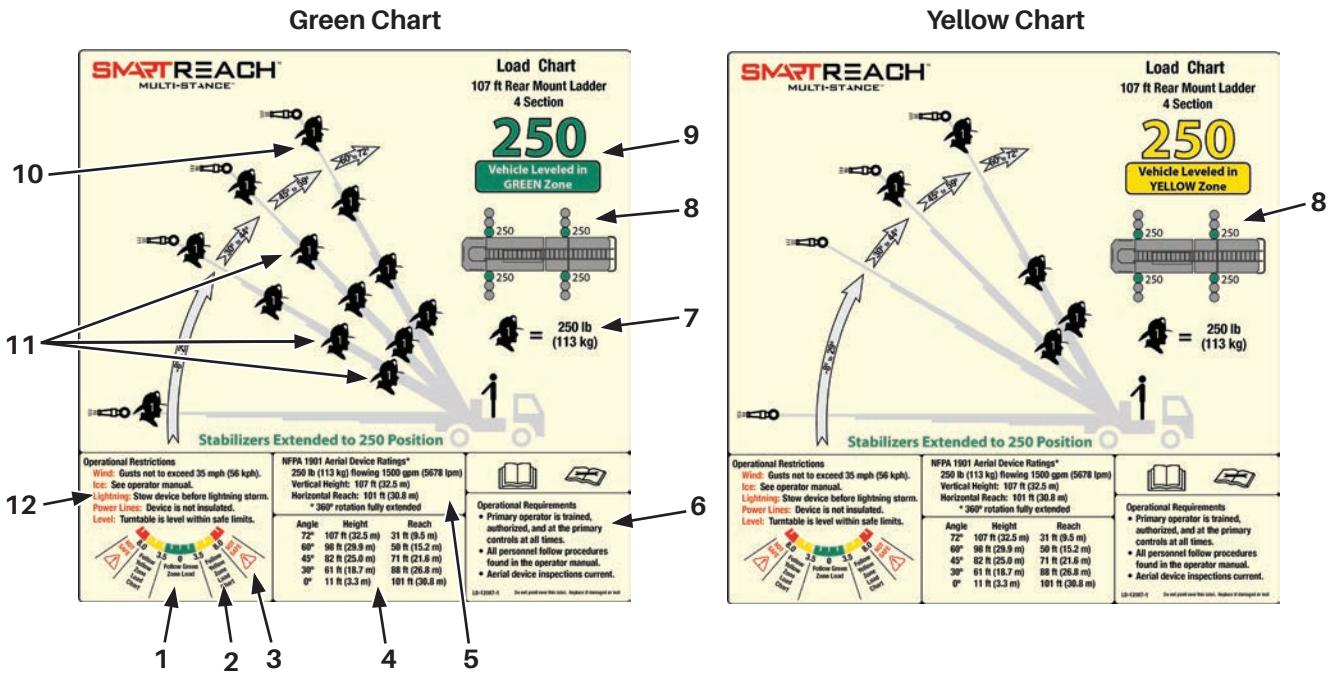

Figure 4-6. 250 lb. (113.4 kg) Static Load Charts

Preparing the Apparatus for Ladder Operations

Pre-Operation Readiness

Prior to operating your aerial ladder, inspect the apparatus and aerial ladder in accordance with Section 5 of this manual and your Department's procedures.



Read and follow the instructions found in the **Safety Section** of this manual pertaining to driving and riding safely prior to operating. (see page 2.23.)



Read and follow the instructions found in your **Chassis Operator Manual** prior to operating. Before driving your apparatus you must make sure it is safe and in good working order. Follow the pre-trip inspection found in your chassis operator manual



Before operating the aerial ladder read and follow the **Prepare For Safe Operation** instructions found in the safety section of this manual. (see page 2.1)

Selecting a Set-up Site



Read and follow the **Safe Aerial Set-Up** instructions found in the safety section of this manual.

Using a spotter, position your apparatus at a site that meets the following criteria:

- As flat and solid as possible (i.e., reinforced concrete, asphalt, etc.).
- Avoid manhole covers, sewer lids and grates, non-compacted gravel or soil, etc.
- Use cribbing or shoring to spread out load if setting up on soil or other soft surfaces.
- Provide room for stabilizer deployment on both sides or provide room for stabilizer deployment on the side over which the ladder will be used.
- Clear of overhead obstructions such as electrical cables, buildings, trees, etc.
- When possible, position the apparatus to operate the aerial over the side or rear to provide maximum reach and low angle operation.
- Position to minimize water monitor spray onto the ladder to avoid ice build-up in freezing temperatures.
- Position apparatus outside of collapse zones or high heat areas.

OPERATING PROCEDURES

Provide Aerial Power

To provide electric and hydraulic power to aerial systems, follow instructions in the chassis manual to start the engine.

1. Ensure the **Parking Brake** is set.
2. Ensure the **Front Wheel Lock** is set (if so equipped).
3. Place **Transmission Selector** in neutral.
4. Activate the **Aerial Master** switch.
5. Ensure that the engine speed is 1200 RPM or less.
6. Activate the **PTO** switch.

Engaging the Fire Service Pump after the PTO is in Operation

If the PTO has been engaged and it now becomes necessary to engage the fire service pump, follow these steps.

1. Deactivate the **High Idle Switch** if in use.
2. Engage the fire service pump using the procedures found in the pump operation manual.
3. Place the **Transmission Selector** in drive.
4. The fire service pump and aerial ladder are now both operational. The high idle function is now disabled.
5. Use the fire service pump controller to set the engine speed for required discharge pressure.

Engaging PTO after the Fire Service Pump is in Operation

If the fire service pump has been engaged and the engine speed set to supply pressure, and it then becomes necessary to engage the PTO for aerial, EHL, or hydraulic generator operation, follow these steps.

1. Lower the RPM's of the engine to 1200 RPM or less.



Prior to lowering the engine RPM, and subsequently the pump discharge pressure, ensure that lowering the discharge pressure WILL NOT impact the safety of firefighters, or fire fighting operations.

2. Activate the **Aerial Master** switch. (The high idle function is now disabled.)
3. Activate the **PTO** switch.
4. Use the fire service pump controller to set the engine speed for required discharge pressure.

Automatic High Idle Function

Automatic High Idle raises the engine speed to high idle (1250 rpm) when a stabilizer or aerial ladder control lever is activated. Five seconds after the lever is released, engine speed is returned to normal idle speed.

Automatic High Idle is the default setting. If you prefer, or your department procedure is to use, continuous high idle, activate and deactivate the high idle function with the button in the cab.

When the fire pump is engaged, neither automatic or the **High Idle** button in the cab will function.

Wheel Chock Positioning



Figure 4-7. Wheel Chocks

1. Place chocks on those tires that will have the greatest contact with the ground after stabilizer deployment.
2. Place chocks on the downhill side of tires if positioned on a grade.
3. Place chocks on both sides of the tires if positioned on level ground.

Stabilizing the Apparatus



Read and follow the **Safe Aerial Set-Up** instructions found in the safety section of this manual

Stabilizer Pads

The standard stabilizer configuration has a fixed jack pad that is large enough to provide the required distribution of load when the stabilizers are deployed and have the weight of the apparatus on them. If your aerial ladder is equipped with separate auxiliary stabilizer pads, these must always be used when the stabilizers are deployed and the ladder is put into operation.

Stabilizer Beam Extension

1. Clear all personnel from the stabilizer deployment area.
2. Inform personnel that you are about to set stabilizers.
3. Ensure that the audible warning is sounding when a stabilizer control is activated.
4. Use the **Beam Controls** to extend all stabilizer beams as far as possible.

OPERATING PROCEDURES

5. If equipped with auxiliary stabilizer pads, position these pads under each jack with the handle positioned between the jack and the apparatus body.

Leveling Apparatus Equipped with Four Stabilizers

Front and Rear Outriggers or Rear Outriggers and Front Jacks

Using Manual Controls

1. Using the **Stabilizer Jack Controls**, lower the jacks on one side of the apparatus, making contact with the ground and raising that side several inches so that either the bulge is out of the sidewalls of the tires, or lifting the tires off the ground.
2. Lower the jacks on the opposite side until the side to side **Level Indicator** is in the green zone, as close to zero degrees as possible and either the bulge is out of the sidewalls of the tires, or the tires are off the ground.
3. Check that the front to back **Level Indicator** near the turntable access ladder is in the green zone, and as close to zero degrees as possible.
4. If the apparatus is parked on a slope;
 - Lower the jacks on the uphill side of the apparatus first, just making contact with the ground.
 - Lower the jacks on the downhill side until the appropriate **Level Indicator** is in the green zone, as close to zero degrees as possible.

NOTICE

Refer to load chart and Safety Section of this manual for operation in the yellow range.

- When leveling on a slope with ice or snow conditions, always leave one set of tires in contact with the ground. Place wheel chocks on these tires.



Figure 4-8. Leveling an Apparatus with 4 Stabilizers

NOTICE

Operation of the aerial ladder over the cab is permissible with the front tires off of the ground.

5. Ensure that all **Jack Down Indicators** at the stabilizer control station are illuminated.

Using the Automatic Leveling System

CAUTION

Have a spotter watch the jack movement on the side of the apparatus you are unable to observe. Keep people away from pinch points.

Your apparatus is equipped with an Automatic Leveling system.

1. Extend the stabilizer beams and set the auxiliary pads, if equipped, as described in "Placing the Auxiliary Stabilizer Pads". (see [page 4.9](#).)
2. Activate the Automatic Leveling system by pressing the Auto Level Icon on the stabilizer control screen or the Auto Level Switch.
3. Observe each side of the apparatus so that you can ensure that all personnel are clear of the area. Position a spotter to watch one side while you are watching the other side. Keep your spotter in full view during the leveling process.
4. Push down and hold any one of the jack control levers or the wired remote button, if equipped. Watch while all jacks deploy simultaneously until there is ground contact.
5. Continue pressing the Jack Control, or button, until all jacks stop extending and the Stabilizer Screen shows Leveling Complete.

NOTICE

If at any time one of the jacks loses its plant condition, the leveling process will be stopped and the offending jack will deploy until the weight on jack condition is true again. Continue pressing the Jack Control, or button, during this process.

6. Ensure that all Jack Down Indicators at the stabilizer control station are illuminated.
7. Check both level indicators to verify the load zone the apparatus is in - 100%, 50% or 0%. Manual adjustment of the jacks may improve the load zone.
 - Pushing down on a jack lever will extend all jacks. Release the jack lever to stop movement. This may be done if needed to get bulges out of the tires or take them off the ground.
 - If you need to make adjustments to individual jacks, turn off the automatic leveling system by pressing the Auto Level Icon on the Stabilizer Display, pressing the Auto Level Switch, or moving a Jack Control up to the raise position and releasing.

Leveling Apparatus Equipped with Rear Stabilizers Only

1. Using the **Stabilizer Jack Controls**, lower the jacks on one side of the apparatus, making contact with the ground, and raising that side several inches to take the bulge out of the sidewalls of the tires.
2. Lower the jacks on the opposite side until the side to side **Level Indicator** is in the green range, as close to zero degrees as possible and the bulge is out of the tire sidewalls (tire are off the ground).

OPERATING PROCEDURES

3. Check the front to back **Level Indicator** near the turntable access ladder is in the green range, as close to zero degrees as possible.
4. If the apparatus is parked on a front to back slope;
 - If the location where the apparatus must be positioned is on a front/back slope, the apparatus must be parked with cab in the uphill direction.
 - Lower the jacks and raise the rear of the apparatus until the front to back **Level Indicator** is in the green range, raising the rear tires off the ground if necessary.

NOTICE

Refer to load chart and Safety Section of this manual for operation in the yellow range.

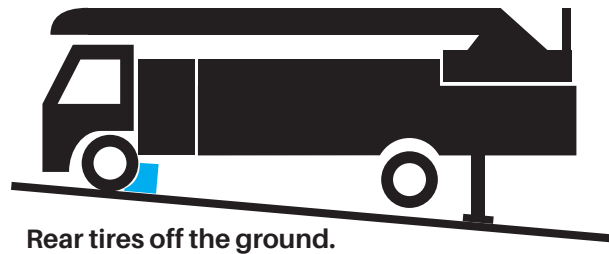

Figure 4-9. Leveling an Apparatus with 2 Stabilizers

5. Ensure that all **Jack Deployed Indicators** are illuminated.

Short-Set Operation

You may operate your aerial ladder over any side where the stabilizers are deployed sufficiently to allow the minimum tip load rating. If one or both stabilizers cannot be extended far enough to achieve a 250 lb. (113.4 kg) tip load, only the Alley Jack procedure will be allowed on that side of the apparatus. This is known as a Short Set condition.

WARNING

Read and follow the instructions found in the safety section of this manual pertaining to **Safe Aerial Set-Up**. Assign a safety observer to ensure that safe practices are followed with the apparatus set up in a short-set configuration.

1. Extend the stabilizer beams on the working side of the apparatus enough to achieve a tip load rating.
2. Extend the stabilizer beams on the short-set side as far out as possible, even though you will not be working off that side. This will improve stability by moving the stabilizer weight away from the center of the truck.
3. If equipped with auxiliary stabilizer pads, position these pads under each jack with the handle positioned between the jack and the apparatus body.
4. Level the apparatus as described in **Leveling the Apparatus**.

5. The stabilizer display will indicate 0 tip load on a short set side.

NOTICE

All stabilizer jacks must be in contact with the ground and load bearing before you can begin aerial ladder operation. The rear stabilizer jack on the non-working side may raise off the ground during normal operation.

Ladder Operations

WARNING

Read and follow the **Operate Your Aerial Safely** instructions found in the safety section of this manual. (see page 2.47.)

Preparing for Ladder Operation

1. Close all **Stabilizer Control** access doors.
2. Deploy the turntable access ladder.
3. Climb onto the turntable platform using the three points of contact method.
4. Secure the safety chain or other device to close off the railing.
5. Open the **Primary Operator Control Station** cover.
6. View the Smart Reach Display and note the ladder load capacities achieved for each side.
7. Make sure your waterway discharge valve at the monitor, if equipped, is open to allow the waterway to extend or retract freely without stressing the seals.
8. If operating at night, turn on scene lights, ladder lights, and/or spot lights and search the operating area for potential hazards.
9. Determine the wind speed and ensure that it is below the maximum allowable wind speed (See a Static Load Chart).
10. During freezing weather conditions, monitor for ice build up on the ladder. Reduce loads or cradle the ladder if ice builds on the ladder.
11. Look for obstacles in your path and plan out how you will avoid them and maintain safe distance from power lines.
12. Keep people on the turntable away from the ladder and other parts on the ladder that will move.
13. Assign spotters to help you avoid hazards that are not visible to you.

OPERATING PROCEDURES

Basic Operations

Communicate to spotters and personnel in the area that you intend to move the aerial ladder.

1. Twist the M Stop button until it pops up and the light illuminates.
2. Depress the **Operator Present Foot Switch**.

NOTICE

If a ladder control is activated and then the Operator Present Foot Switch is activated, no ladder functions will be allowed. Release the ladder control and step off the Operator Present Foot Switch. Now activate the Operator Present Foot Switch, then activate a ladder control.

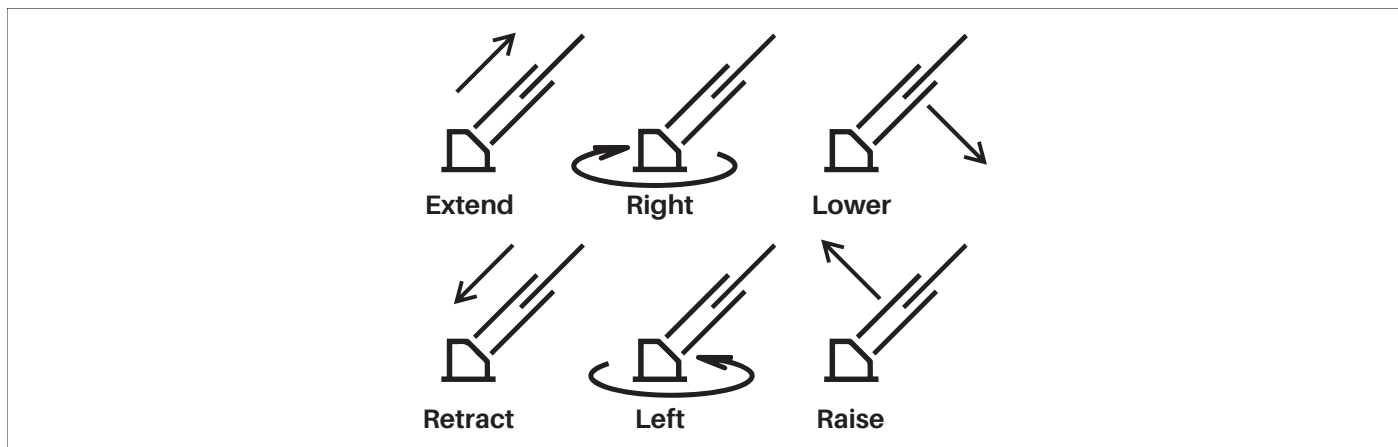

Figure 4-10. Aerial Operation Motions

3. Operate using the **Aerial Extension Control**, **Aerial Rotation Control**, and **Aerial Elevation Control** slowly and smoothly. Place the ladder into operation as follows:
 - Raise the ladder from the cradle to the desired elevation - so that the tip will be above the point you intend to reach (The Target).
 - Ensure that the ladder is elevated sufficiently to avoid collision with other parts of the apparatus.
 - Rotate the turntable so that the ladder is in line with the target.
 - Extend the ladder sections a sufficient length to reach the target.
 - Lower the ladder into the target.
 - Do not rest the tip of the ladder on anything. Ladder must remain a cantilever, unsupported, configuration.

WARNING

Stopping any aerial function rapidly may cause the device to jerk. Operating with a jerking motion is less safe and may be damaging to your device. As you approach full elevation, the hydraulic system will slow and then stop elevation when you reach the end of the elevation travel. Anticipate both the speed change, and the end of elevation travel point, and feather the controls appropriately.

WARNING

This device is equipped with ramped start and stop controls. Ramping slows the ladder motion smoothly to prevent the device from whipping. To stop the device smoothly, the device must remain in motion briefly after you have returned a control lever to the neutral position. Operators must become familiar with the ramping feature and learn to anticipate the extra motion that occurs. Practice stopping device motion in a controlled environment. Failure to anticipate the ramping feature when working close to people or structures may cause injury or death.

4. Utilize the **Speed Control** to increase or decrease the speed of ladder movements. The ladder speed setting also affects ramping. The slower the speed, the less ramping. The higher the speed, the more ramping.
5. The **Ramp Rate** control may also be used to adjust the amount of ramping. Default is "Normal". If more ramping is desired, select "Slow". If less ramping is desired, select "Fast".
6. Approach the ground or any structure slowly and carefully, stopping before you make contact. Your ladder is not designed for reverse loading and you should never power your ladder into the ground or onto a structure.



Always maintain clearance.

Figure 4-11. Maintain Sufficient Ladder Clearance

7. Step off the **Operator Present Foot Switch** to lock out the ladder controls when the ladder is in position. Particularly when firefighters or other persons are climbing the ladder.
8. Monitor the load on the ladder and do not exceed the allowable loads indicated on the Smart Reach Aerial Display or the appropriate static load chart.
9. During cold weather, monitor the ladder for ice buildup. Extend and retract the ladder to minimize ice buildup.

OPERATING PROCEDURES

10. During Ladder operations, with the apparatus leveled in the yellow zone and very close to the red zone - If the apparatus moves into the red zone, ALL ladder functions will be stopped except retraction. If there are people on the ladder, have them climb down and get off the ladder. Retract the ladder sufficiently to regain the yellow zone. Reposition Stabilizer Jacks to improve the leveling position of the apparatus or limit extension, loading, and/or water flow operations.

Rotating the Ladder into a Reduced Capacity Zone

When attempting to rotate the ladder into a reduced capacity zone 500 lbs. (226.8 kg) or 250 lbs. (113.4 kg) tip load, the ladder rotation will stop automatically. An alert message will appear on the Smart Reach Aerial Display. To continue in the same direction of rotation:

1. Observe the number of personnel on the ladder and ensure you will not exceed the reduced load for the zone you are entering.
2. Activate and hold the **Enable** button.
3. Rotate the ladder into the reduced capacity zone.
4. Release the **Enable** Button.
5. Continue operating the ladder while adhering to the reduced load capacity shown on the load chart.

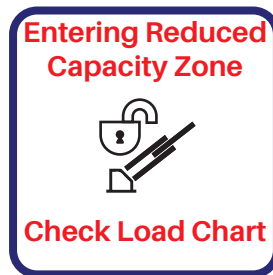

Figure 4-12. Entering Reduced Capacity Zone Message

Alley Jack Procedure

If faced with a situation where you need to rotate the ladder through a short set side of the apparatus to get to a side with an allowable load (i.e., To work off the rear of the apparatus.), this can be accomplished as follows;

1. Fully raise the ladder - 72 degrees F.
2. Fully retract the ladder.
3. Rotate the ladder through the no load zone. Extension and elevation controls will not function when the ladder is in the no load zone.
4. Once the ladder is in an allowable load zone, all ladder controls will function.

Stowing the Aerial Ladder

Stowing the Ladder

1. Fully retract the ladder.

2. If your apparatus is equipped with a monitor stow feature make certain that the monitor stow light is illuminated. If it is not, activate the **Monitor Stow Control** in order to stow the monitor and illuminate the stow light.
3. Manually stow the ladder by -
 - Rotating the ladder until it is over the cradle. The bed zone light will not illuminate until the ladder is over the cradle and, if equipped, the monitor is properly stowed with the monitor stow indicator illuminated.
 - Lower the ladder into the cradle, making sure that the bottom rail of the ladder is aligned with the cradle.
4. Stowing the Aerial Using Auto Stow -
 - Position the ladder less than 10° above and within 5° to either side of the cradle.
 - Press and hold the Aerial Auto Stow button. If you need to stop auto stowing, release the button.
 - When the ladder is in the cradle and movement has stopped release the button.

CAUTION

Do not use Auto Stow feature if the apparatus is setup in a manor that puts a twist in the apparatus body. This condition may cause the cradle to be slightly out of alignment with the turntable.

5. Ensure that the ladder is firmly bedded in the cradle.
6. Step off the **Operator Present Foot Switch** and depress the M Stop button.
7. Turn off any lights that were on during ladder operations.
8. Close **Primary Operator Control Station** cover.
9. Climb off the turntable using the access ladder and the three points of contact method.
10. Stow the turntable access ladder.

Stowing the Stabilizers

1. Check the wheel chocks to make certain they can be removed. Use the **Stabilizer Jack Controls** to take pressure off of the chocks and reposition if necessary.
2. Clear the area of personnel.
3. Raise the jacks on the low side of the apparatus.
4. Raise the jacks on the high side of the apparatus.
5. Retract the stabilizer beams fully.
6. Place the auxiliary pads in the pad storage locations, if equipped.
7. Move the **PTO** switch to the OFF position, unless required for other apparatus functions.
8. Move the **Aerial Master** switch to the OFF position.

OPERATING PROCEDURES

Ladder Optional Features

Pre-Piped Waterway and Monitor

Your apparatus may be equipped with a pre-piped waterway that will provide a continuous path for water flow from the aerial inlet or fire service pump to the monitor at the tip of the ladder. To use the pre-piped waterway follow this procedure:

Deployment and Operation



Read and follow the **Work Safely** instructions found in the safety section of this manual.

1. Deploy the monitor so that the nozzle is directed at the fire. This may be accomplished manually or by activating an automatic deploy feature. (If Equipped)
2. Charge the waterway - Open valves slowly to prevent a water hammer in the piping or a shock load to the ladder due to excessive nozzle reaction.
3. Do not exceed 240 psi (1654.74 kPA) in the waterway system. A relief valve is mounted on the bed section of the waterway. This is factory set to discharge at 240 psi (1654.74 kPA) to protect the waterway system if water is trapped in the waterway and retracted.
4. Watch the flow meter and adjust the pressure to optimize the amount of water flowing.



Do not exceed the maximum flow capacity as stated on the load chart. Excessive nozzle reaction forces may result in instability, damage, injury or death.

The automatic nozzle or smooth bore tips may be used on the monitor.

- When using smooth bore tips, select the appropriate size tip for the available water supply.
- Insufficient water flow or poor stream quality may result from improper tip size.

Monitor Travel

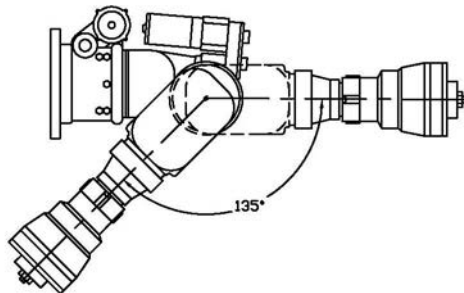

Figure 4-13. Nozzle Motion - Standard Range

The standard range monitor can be directed through the full range of motion with no change to tip load.

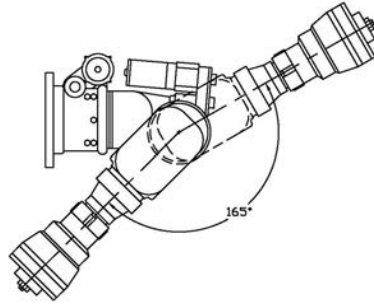

Figure 4-14. Nozzle Motion - Extended Range

The extended range monitor travels an additional 0 and 30 degrees up past the ladder centerline. When in this position and flowing water, reduce the tip load by 250 lb (113.4 kg). Observe the Ladder Screen, the allowable load will be reduced when the monitor is in the extended range.

CAUTION

If your waterway is equipped with a positional mode feature (See page 4.19), only utilize the extended range when in the water tower mode. Damage to the monitor, nozzle and ladder may occur if the monitor is in the extended range and the waterway is in Rescue Mode.

NOTICE

There is an interlock that prevents the monitor from being elevated into the extended range when the waterway is in the rescue mode. This interlock automatically moves the monitor from extended to standard range if the position of the waterway is switched from water tower to rescue mode.

Draining the Waterway and Stowing the Monitor

1. When finished using the pre-piped waterway, shut off the water supply to the ladder.
2. Shut valves slowly to prevent a water hammer to the fire service pump, water supply hose, and water mains.
3. Drain the waterway system using the following procedure.
 - Raise the ladder a minimum of 30 degrees.
 - Fully extend the ladder.
 - Open the waterway drain valve located near the aerial intake connection on the rear or side of the apparatus.
 - If equipped with a fire service pump, open the waterway drain valve located on the pump panel.
 - When complete, close all drains.
4. Stow the monitor by either manually positioning the monitor to your department's travel position or, if equipped, by activating the **Stow button**. While the monitor is traveling, the indicator light ring is green. When the Monitor is stowed, the indicator is blue.

OPERATING PROCEDURES

Positional Waterway

Your ladder may be equipped with a positional waterway feature that secures the monitor at the tip of the fly section or the end of the next lower section. The different positions are:

- Water Tower Mode - Monitor secured to the end of the fly section.



Figure 4-15. Monitor at the end of the Fly Section

- Rescue Mode - Monitor secured to the next section back from the fly section to avoid monitor damage when working near structures.



Figure 4-16. Monitor at the end of Next Lower Ladder Section

To change the position of the monitor from RESCUE Mode to WATER TOWER Mode;

1. If flowing water through the waterway, shut this off and open a waterway drain.
2. Elevate the ladder to 20 degrees or more.
3. Fully retract the ladder ensuring that all sections are firmly seated together
4. Press the Water Tower Button. Observe the indicator light -
 - Solid blue indicates proper alignment, ready for extension.
 - Solid red indicates a misalignment and the ladder will not extend.
5. As you extend the ladder watch the monitor to verify that it is in the correct position.

CAUTION

If the indicator light illuminates red, or the monitor is not engaged with the tip of the fly section, do not use the waterway until the device has been repaired.

6. The waterway can be charged and water flow operations conducted.

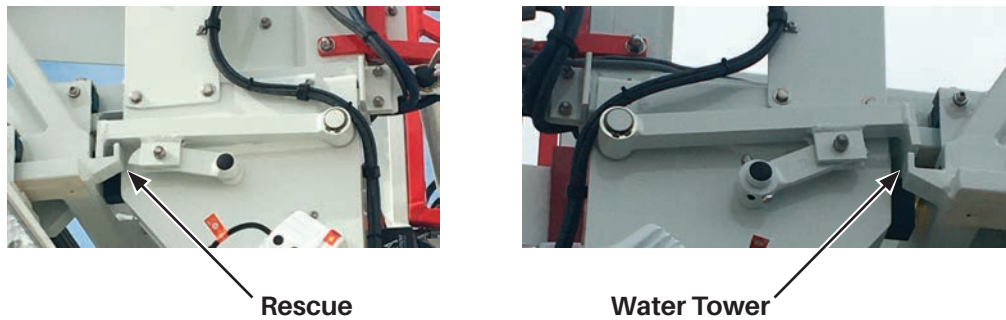

Figure 4-17. Positional Waterway Controls and Lock

To change the position of the monitor from WATER TOWER Mode to RESCUE Mode;

1. If flowing water through the waterway, shut this off and open a waterway drain.
2. Elevate the ladder to 20 degrees or more.
3. Fully retract the ladder ensuring that all sections are firmly seated together.
4. Press the Rescue Mode Button. Observe the indicator light –
 - Solid blue indicates proper alignment, ready for extension.
 - Solid red indicates a miss alignment and the ladder will not extend.
5. As you extend the ladder watch the monitor to verify that it is in the correct position.

CAUTION

If the indicator light illuminates red, or the monitor is not engaged with the end of the next lower ladder section, do not use the waterway until the device has been repaired.

6. The waterway can be charged and water flow operations conducted in Rescue Mode.

Aerial Standpipe Connection

If the waterway system is equipped with an aerial standpipe connection, this provides a gated 2-1/2 in. (63.5 mm) hose connection at the monitor.



Figure 4-18. Aerial Standpipe Connection

1. Set the positional waterway to the WATER TOWER position.

OPERATING PROCEDURES

2. Position the tip of the ladder at the desired location to attach hose lines.
3. Close the monitor control valve.
4. Connect hose lines to the 2-1/2 in. (63.5 mm) outlet and deploy the hose lines.
5. Charge the waterway to the desired pressure.
6. Slowly open the 2-1/2 in. (63.5 mm) control valve to charge the hose lines.
7. When hose line operations are completed:
 - Shut off the water supply to the ladder.
 - Shut off the 2-1/2 in. (63.5 mm) control valve to the hose lines.
 - Disconnect hose lines and replace cap on connection.
 - Open the monitor control valve fully.
 - Drain the waterway as described in ("Pre-Piped Waterway and Monitor" on [page 4.18.](#))

Secondary Operation from the Ladder Tip Control - Optional

Your aerial ladder may be equipped with secondary tip controls that will allow an operator at the tip of the ladder to make small adjustments to the ladder position. This secondary position must only be used with a trained, experienced, and authorized operator at the primary operator control station. It is the job of the primary operator to watch for hazards, and to regain control of the ladder prior to encountering any unsafe condition.

To make fine adjustments to the aerial ladder position from the ladder tip, use the following procedures:

1. Use the **Aerial Extension**, **Aerial Elevation**, and **Aerial Rotation** controls at the Primary Operator Control Station to position the ladder near the target
2. Extend the ladder out so that the foot-rests on the fly section are beyond the next lower ladder section. Ensure that the ladder rungs are aligned for climbing.
3. Step off the **Operator Present Foot Switch** and allow a firefighter to climb to the ladder tip.
4. The firefighter at the ladder tip shall attach their fall protection tether to the center of a ladder rung at the point of the K-brace.
5. Deploy the folding steps.
6. Place both feet on the folding steps.
7. Establish communication with the primary operator.
8. Request permission to operate the **Ladder Tip Controls**.
9. The primary operator should depress the **Operator Present Foot Switch** and activate and hold the **Controls Enable button**.
10. The secondary operator can move the ladder by using the proportional **Ladder Tip Controls** at the tip of the ladder. Ladder will operate from 0% to approximately 30% of full speed.

The primary operator may stop ladder tip operations by either releasing the **Control Enable button** or stepping off the **Operator Present Foot Switch**.

Wireless Remote Control Monitor Operations - Optional

Your aerial ladder may be equipped with a wireless remote control for the monitor. This is provided by the monitor manufacturer. Operation is by powering up the control and activating the appropriate toggle switch for the movement you desire.

NOTICE

Remote control incorporates a battery saver feature, inactivity of the function switches will render remote non-functional. To reset, shut off power switch momentarily and reactivate.

Rope Rescue System

Your apparatus may be equipped with a Rope Rescue System that includes both a Roller Assembly and Change of Direction Bar. These devices must always be used together.

Change of Direction Bar

The change of direction bar is designed to be used as the lower anchoring point (fixed end) for rope and related equipment tie-offs.

1. Remove the Change of Direction bar from its storage bracket on the side of the bed section of the ladder.
2. Attach the change of direction bar to the end of the handrails at the bottom of the ladder base section.
3. Lock into place by using the two factory-supplied safety pins.



Figure 4-19. Change of Direction Bar in Stowed Position



Figure 4-20. Change of Direction Bar in Mounting Brackets

OPERATING PROCEDURES

Rope Rescue Roller Assembly

The Roller Assembly is intended to be used for rope rescue operations only.



Read and follow the **Rope Rescue** instructions found in the safety section of this manual. (see page 2.56.)

The capacity of the pulley system is the remaining tip load after subtracting for equipment or personnel. Tie off the fixed end of the rope to the Change of Direction Bar.

Do not allow rescue safety rope to come in contact with abrasive surfaces. Ladder rungs are abrasive and will cause damage to rescue safety rope. Failure to comply may result in death or serious injury.

Set up the Rope Rescue Roller assembly using the following procedure:

1. Place the positional waterway into the Rescue Mode.
2. Step off the **Operator Present Foot Switch** to lock out the ladder controls.
3. Remove the roller assembly from the mounting bracket located on the outside of the bed section of the ladder.
4. Attach the roller assembly to the fly section on the last rung before the bolt-on egress. Lock into place on the provided rung locking point only.
5. The over center locking pin must be aligned and inserted into the provided locking point hole.

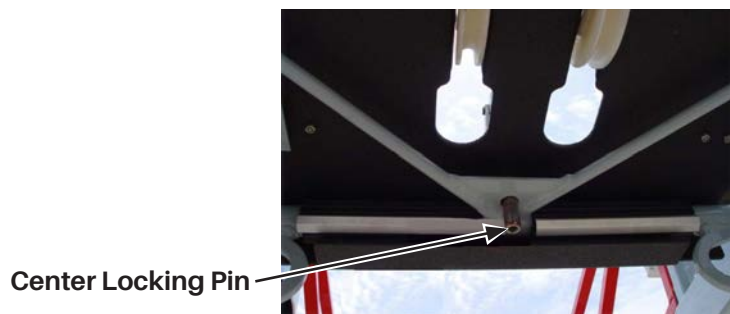

Figure 4-21. Center Locking Pin

6. Place the over center locking pin handle into the locked position.

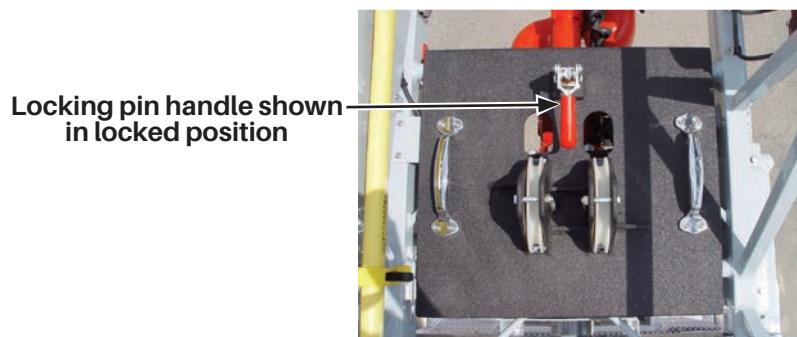

Figure 4-22. Locking Pin Handle in Locked Position

Breathing Air System

Follow all applicable local breathing air regulations including all NFPA standards.

Use caution when removing connections and fittings from high pressure devices. If a device is unusually difficult to remove, check for trapped pressure.

Refill the cylinders as follows:

1. Open cylinder access covers.
2. Inspect breathing air system and cylinders for damage.
3. Check cylinders for current certifications and hydrostatic test dates.
4. Identify service pressure stamped on the cylinder or cylinders to be filled.
5. Remove cap slowly from the aerial refill CGA fitting and connect filling system fill hose to the aerial CGA male connector.
6. Open the aerial storage cylinder valve or valves to be filled slowly and completely
7. Set breathing air filling system to the correct pressure.
8. Open breathing air filling system to the recommended fill rate as per the system manufacturer or local jurisdiction, as applicable.
9. Start filling the ladder system.
10. Shutdown filling system when cylinder or cylinders are full.
11. Close aerial storage system cylinder valve or valves.
12. Bleed system fill line and then remove from aerial fill connection.
13. Reinstall cap on aerial fill connection.
14. Check aerial breathing air system for leaks.
15. Properly close and lock cylinder access covers, stow all equipment.

Recalibration of the Airminder System may be needed. See Airminder Owner's Manual for proper recalibration procedures.

Breathing Air Operation

Open storage cylinder valve or valves slowly and fully to supply air to the aerial breathing air system.

Supply air pressure is monitored by an Class 1 Airminder and is reflective of what cylinder valve or valves are opened.

Airminder Display will flash and an audible alarm will sound when approximately 30% air is remaining in supply air.

OPERATING PROCEDURES

Rescue and Firefighting Equipment Stored on Ladder

Any equipment that is to be carried on the ladder must be secured in approved mounting brackets, hardware and enclosures.

- Verify that all equipment is stored in its proper location.
- Verify that all equipment is secured with positive locking devices such as brackets and locking straps, covers, pins, etc.

Ergonomic Hose Load (EHL)

Your apparatus may be equipped with an Ergonomic Hose Load (EHL) hose storage area. When the EHL is supplied on an aerial apparatus, the hydraulic system is utilized to power it. Therefore, all conditions that must be met for the aerial unit to operate, must also be met to operate the EHL.

To extend the EHL:

1. With the engine running, engage the **Aerial Master** and **PTO** switches.
2. Open the rear access door to the EHL.
3. Open the left stabilizer control panel.
4. Locate the EHL control switch and activate and hold the switch to extend the EHL. An audible alarm will sound when this switch is activated.
5. Watch the movement of the EHL to make certain that no one is touching the EHL or in the path of the deployment.
6. The EHL will extend out horizontally, then lower to the hose loading height.
7. When the EHL stops all movement, release the control switch.

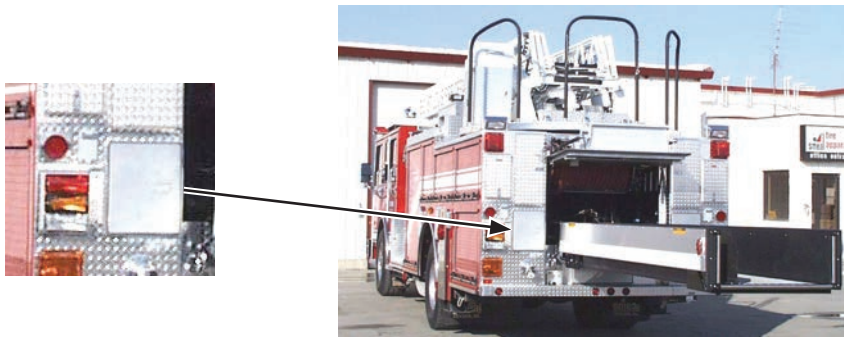

Figure 4-23. EHL Location



Never place your apparatus in motion with the EHL extended.



Figure 4-24. Crash Hazard

To Stow the EHL

Make certain that all personnel are not touching and are away from EHL.

1. Active the control switch to stow the EHL.
2. Once the EHL is completely inside the apparatus body and stops, release the control switch.
3. Close EHL access door.
4. Disengage the **Aerial Master** and **PTO** switches.

Operation of Safety Interlock Overrides and Backup Systems



The safety interlocks on your aerial ladder are intended to reduce the risk of damage, injury or death due to improper operation of the aerial ladder. The safety of your aerial apparatus is the responsibility of the trained, experienced, and authorized operator. Never rely on interlocks to keep you safe. **ALWAYS** operate the ladder properly, within the safe limits as described on the load chart.

Interlock overrides are provided so that you can take charge and bypass the safety interlock in the event that a sensing component fails and this failure is preventing you from stowing your aerial ladder and removing it safely from service. Safety interlock overrides should never be used in this case to continue normal operation. Remove personnel from the ladder, operate within the load chart limits, and remove the apparatus from service immediately until it can be properly repaired. The use of any safety interlock override must be appropriate for the condition or situation, improper use could result in death, injury to personal, or apparatus damage.

When the **Safety Interlock Override** control is activated, a warning message will appear in the Smart Reach Display advising that you have disabled the interlock systems.



Figure 4-25. Interlocks Disabled Message

Rotation Limiting for Stabilizer Short Set



Read and follow the instructions found in the safety section of this manual pertaining to **Safe Aerial Set-Up**. Assign a safety observer to ensure that safe practices are followed with the apparatus set up in a short-set configuration. (see page 2.1.)

The ladder is equipped with a turntable rotation limit interlock system that will prevent the turntable from being rotated on the side of the apparatus where the stabilizers have been sufficiently deployed, but the system is showing a short-set condition. To override the short-set rotation interlock use the following procedure:

1. Check to make sure that the stabilizers on the working side of the apparatus have been extended far enough to achieve a tip load rating.
2. Check to make sure that each jack, on all sides of the apparatus are in contact with the ground and have the weight of the apparatus on the jacks and not the suspension.
3. Locate the **Safety Interlock Override** at the stabilizer control station and the Aerial Ladder Manual Overrides on the turntable just below the right heel pin of the ladder.
4. Have a second operator push and hold the **Safety Interlock Override** switch in the AERIAL position.
5. The primary operator can rotate the ladder using the manual ladder rotation control.
6. For all other ladder movements use the appropriate control, do not operate the **Safety Interlock Override** knob.



Rotating the aerial to a side where the stabilizers are not sufficiently extended and planted will result in overturning of the apparatus and possible death, injury to personal, and/or apparatus damage.

Ladder/Stabilizer Interlock

The hydraulic fluid distribution system is engineered to provide hydraulic fluid to either the stabilizer circuit or the ladder circuit, not to both at the same time. This prevents operation of the stabilizers when the ladder is raised or raising of the ladder if stabilizers are not deployed.

A sensor on the ladder cradle is an integral part of this safety system. If this sensor fails, raising the ladder from the cradle or operating the stabilizers when the ladder is in the cradle, may be prevented.

There is a "load" sensor on each stabilizer jack that is an integral part of this safety system. If one of these sensors fail, the ladder will not raise out of the cradle.

Your aerial apparatus is provided with a means to override this interlock. This override should only be used by maintenance personnel in the process of making repairs, or returning the aerial to stowed position for transport. Never continue to operate your aerial apparatus in normal operation if the Ladder/Stabilizer Interlock is active or if any of these sensors are defective. Follow these procedures to override a defective sensor interlock.



Read and follow the instructions found in the safety section of this manual pertaining to **Safe Aerial Set-Up. Assign a safety observer to ensure that safe practices are followed any time an interlock is being over-ridden. (see page 2.1.)**

For Ladder Operation

1. Locate the **Safety Interlock Override** switch at the stabilizer control station.
2. Make certain that all stabilizer jacks are in contact with the ground and that the weight of the apparatus is on the jacks and not the suspension.
3. Have a second operator push and hold the **Safety Interlock Override** switch in the AERIAL position while the operator at the **Primary Operator Control Station** raises the ladder out of the cradle and operates the ladder.
4. Once the ladder is out of the cradle, the switch can be released, the ladder will operate normally.

For Stabilizer Operation

1. Locate the **Safety Interlock Override** switch at the stabilizer control station.
2. Make certain that the ladder is securely in the cradle.
3. Have a second operator push and hold the **Safety Interlock Override** switch in the STABILIZER position while the operator at the stabilizer controls deploys or stows the stabilizers.

Bed Zone/Body Collision System Interlock

This ladder is equipped with an interlock that will stop rotation or lowering of the ladder so that the cab or the apparatus body is not accidentally damaged by the ladder. This body collision envelope is programmed with the cab and all movable features, such as lights, deck guns, etc. in the road ready position. The BODY COLLISION PREVENTION SYSTEM does not know if the cab is tilted, lights are extended, etc. When the system determines that the ladder is in alignment with the cradle and all other collision prevention interlocks are satisfied, you will be allowed to lower the ladder into the cradle.

In the event that the Cradle Aligned icon will not illuminate and the ladder will not go into the cradle, follow this procedure to stow your ladder.

OPERATING PROCEDURES

CAUTION

A defective body collision interlock will no longer prevent you from damaging your cab or body. Assign a safety observer to ensure that safe practices are followed any time an interlock is being overridden.

1. Ensure that the water monitor is in the stowed position.
2. Align the ladder with the cradle.
3. Have a second operator activate and hold the **Safety Interlock Override** switch at the Stabilizer Control Station, in the Aerial position.
4. Cradle the ladder using the Aerial Ladder Manual Overrides on the turntable just below the right heel pin of the ladder.
5. Have the second operator release the **Safety Interlock** override switch.

Emergency Power Unit (EPU)

Your aerial apparatus includes a backup hydraulic pump to provide emergency hydraulic power in case of an engine failure, main hydraulic pump failure, or loss of hydraulic fluid. The pump is powered by a 12 volt motor that runs off the apparatus batteries, or a 120 volt motor that is powered by a line voltage power source (optional). The EPU's hydraulic pump inlet tube is mounted lower in the reservoir than the main pump inlet. This provides a back up reservoir of sufficient capacity for emergency use only.

CAUTION

The EPU pump is not intended for frequent or prolonged use.

Never operate the EPU without a ladder or stabilizer control in operation. When powered by the EPU, the ladder operates at a slower speed than normal.

The 12-volt EPU has a duty cycle that must be observed or the pump may burn out. The pump may be operated for a maximum of 5 minutes in every 60 minutes. The 120-volt EPU does not have this duty cycle restriction.

Operation of the 12-volt EPU is as follows;

1. Provide Power to the EPU
 - Ensure that the engine is running or the ignition switch is in the ON position.
 - Activate the **Aerial Master** switch.
 - Place the **PTO** switch in the OFF position.
2. Aerial Operations
 - Verify that the monitor is in the correct position before stowing the ladder.
 - Activate the **Operator Present Foot Switch**.

- Activate the **Aerial Extension**, **Aerial Rotation**, or **Aerial Elevation** control for the motion desired.
 - At the same time activate the EPU motor using the **EPU Switch**.
 - When the movement is complete release the control and the **EPU Switch**.
 - Only operate one aerial motion function at a time.
 - Repeat this process until the ladder has been stowed.
 - Monitor the duty cycle time - If you reach 5 minutes of operation and stowing is not complete, stop operations for about one hour to let the EPU cool off.
3. Stabilizer Operations
- Actuate one of the **Stabilizer Controls**.
 - At the same time actuate the EPU motor using the **EPU Switch**.
 - When the movement is complete release the **Stabilizer Control** and the **EPU Switch**.
 - Only operate one function at a time.
 - Repeat this process until all the jacks have been raised and stabilizer beams retracted fully.
 - Monitor the duty cycle time - If you reach 5 minutes of operation and stowing is not complete, stop operations for about 1 hour to let the EPU cool off
4. The ergonomic hose load can be stowed using the EPU.

Operation of the 120-volt EPU is the same as the 12-volt EPU except that you will need to connect a 120-volt power source to the power supply plug for the EPU if applicable, or activation of the high voltage generator or APU is necessary.

Manual Overrides

In the event of partial or total electrical failure, manual overrides can be used to stow the ladder and the stabilizers. The failure may be of the electric over hydraulic controls or failure of the apparatus electrical system, including engine shutdown.



When the ladder or stabilizers are controlled by the manual override valves, safety interlocks are not operational. Operation must be supervised by a trained and authorized service technician. Spotters must be positioned so that any obstructions can be observed. Clear communication between the spotters and the operator is essential.



These overrides should only be used to stow the aerial device and stabilizers, and remove the apparatus from service for repair. These overrides are not intended to provide operation of the aerial device for training or emergency operations.

OPERATING PROCEDURES

Overriding the Diverter Valve Electrical Controls

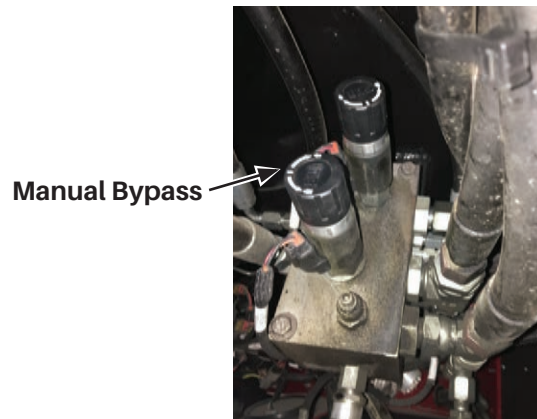

Figure 4-26. Diverter Valve Block

The Diverter Valve is under the rear of the apparatus just ahead of the Outrigger Control Station. Or, behind a panel in the Turntable Access Ladder well on the driver's side of the apparatus. Bypass the interlock as follows;

- Select the bypass for the operation you need to perform.
- Twist the knob counter clock wise until it stops, about 1/3 of a turn.
- Release the knob, the valve will stay open.



When the Diverter bypass Valve is manually opened, safety interlocks associated with this valve are no longer operational. Improper operation of the aerial device may result in damage to the apparatus and injury or death.



NEVER operate the ladder while the stabilizers are not deployed. This could result in the apparatus tipping over, causing damage to the apparatus, injury or death.

Ladder Manual Override Controls

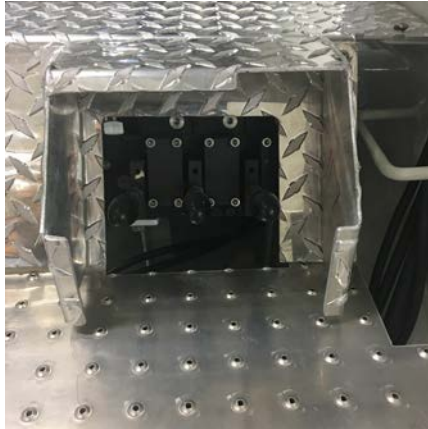

Figure 4-27. Aerial Ladder Manual Overrides

To manually operate the aerial ladder, access the hydraulic control valve by removing the cover under the right side heel pin. There are three control levers.

Depending upon the particular interlock failure you may need another person to hold the override switch at the Stabilizer Control Station in Aerial position, or manually open the Diverter Valve.

Operate the control levers slowly and smoothly.

Stabilizer Manual Override Controls

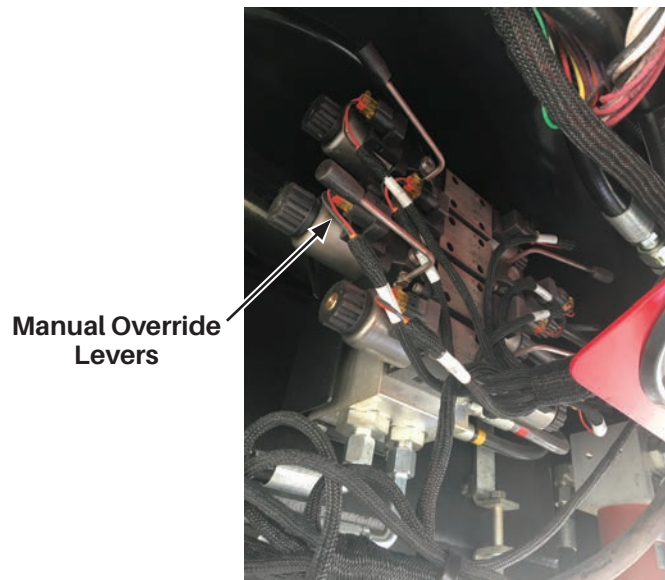

Figure 4-28. Stabilizer Valve Bank and Override Levers

To manually operate the stabilizers, you will need to access the outrigger control valves for the front (if equipped), and the rear stabilizers. The control valves for the rear stabilizers are under the rear of the apparatus just ahead of the Outrigger Control Station. Or, behind a panel in the Turntable Access Ladder well on the driver's side of the apparatus. The control valves for the front stabilizers (if equipped) are located just behind the driver's side front stabilizer.

OPERATING PROCEDURES

- Locate the appropriate stabilizer valve bank. There are two overrides for each stabilizer. One handle raises and lowers the jack, the other extends and retracts the beam, if equipped.
- With a spotter in position, the operator will activate the appropriate override levers to fully raise the jack and retract the beams.

After Manual Operations are Complete

Once manual override operations are complete (ladder and stabilizers are stowed), the operator should, check that both bypass knobs on the diverter valve are returned to the locked (Clockwise) position.

SERVICE PROCEDURES

INTRODUCTION

This section of the operator's manual provides guidelines for service checks, inspections and preventive maintenance that need to be conducted on your aerial device. The items to check and the frequency of the inspections are provided. It is paramount that required inspections and preventive maintenance be properly performed to ensure that the aerial device operates safely and properly.

Some of the inspections are simple visual checks of the aerial device. Other inspections require hands-on operation of the stabilizers and aerial ladder. It is recommended that the inspection, maintenance and testing procedures in this manual and the procedures from the latest edition of the NFPA 1911 - *Standard for the Inspection, Maintenance, Testing, and Retirement of In-Service Automotive Fire Apparatus* be followed to ensure safe, efficient and dependable aerial operation.

ROUTINE INSPECTIONS

Daily checks of the Aerial Device

The following inspections should be conducted daily or at the beginning of each shift.

- Follow department check sheets and standard operating procedures for apparatus inspections.
- Review the maintenance log from the previous shift and make sure any defects have been repaired.
- Review the inspection record to ensure that any scheduled inspections or maintenance has been performed and that the device has been properly adjusted and lubricated.
- Walk the apparatus looking above and below for drips, wet spots, or puddles of fluid.
- Look over the ladder and turntable for;
 - Loose or missing equipment.
 - Any damage to the ladder structure.
 - Damaged rung covers.
 - Branches or other foreign objects in the ladder structure.
 - Cracks in the structure, particularly weld points along the entire ladder and turntable.
- Check aerial device hydraulic fluid level. Check at the site tube on tank or on the Smart Reach screen, with stabilizers and aerial device stowed.
- Check that all control access doors are closed and secured.
- Inspect all mounted equipment on the ladder to ensure it is fastened securely in place.
- Check that the positional waterway (If Equipped) is in the proper position per your department's SOP.
- Check that the Waterway Monitor Control Valve is in the proper position per your department's SOP (if equipped).
- Check that the aerial and all stabilizers are properly stowed.

SERVICE PROCEDURES

- Check that the turntable access ladder(s), pullout platforms, fold down steps, auxiliary pads, and wheel chocks are properly stowed.

Weekly Inspection of the Aerial Device

In addition to the items listed in Daily Checks, the following inspections should be conducted at least weekly.

- In the cab to ensure that aerial related controls function and lights/indicators illuminate.
 - Aerial Master Switch Activates and indicator light illuminates.
 - PTO engages and indicator light illuminates.
- Stabilizer Operation ([see page 4.9.](#))
 - Check auxiliary pads for damage.
 - Deploy the stabilizers as described. Observe the speed and smoothness of all functions while deploying the stabilizers.
 - Stop beam extension at the various tip load indications.
 - Check the beam and jack indicators on the stabilizer screen for correct load indication.
 - Check the stabilizer hydraulic pressure on the [Hydraulic Screen](#) for proper operating pressure.
 - Visually check each stabilizer for fluid leaks, damage, cracks, pin retention, etc.
 - Check all stabilizer warning and scene lights for proper operation.
 - Listen for abnormal noises when operating stabilizers.
- Ladder Operations ([see page 4.13.](#))
 - Raise the ladder out of the cradle.
 - Check the ladder hydraulic pressure for proper operating pressure while raising the ladder at full speed.
 - Visually check elevation / lower, extension / retraction, and rotation components for fluid leaks, damage, cracks, pin retention, etc.
 - Operate the joystick controls paying attention to the speed and smoothness of all ladder functions.
 - Check the Smart Reach Multi Stance™ Load Chart screen to verify correct loads are displayed for the current stabilizer beam extensions.
 - Check that static load charts are in their compartment.
 - Activate all controls for functionality.
 - Rung Alignment.
 - Communication System.
 - Monitor (If Equipped) - All movements function normally.

- Positional Waterway (If Equipped)- Ensure locking mechanism engages with the appropriate latch assemblies in both positions.
- Ladder Tip Controls.
- All low voltage lights on the turntable and ladder.
- Listen for abnormal noises when elevating/lowering, extending/retracting, and rotating the aerial device.

LUBRICATION AND PREVENTIVE MAINTENANCE

Proper lubrication is the most beneficial preventive maintenance prescribed for the aerial device. It is also a warranty requirement!

Lubrication guidelines set forth are specified for normal operation where moderate temperature, humidity and atmospheric conditions prevail. In areas of extreme use, extreme heat & humidity, and/or extreme cold, and/or LACK OF USE; the servicing intervals and lubrication specifications should be adjusted to satisfy existing conditions.

Hour Meters

The importance of proper inspection and lubrication at specified intervals cannot be over emphasized.

- The aerial device is equipped with two hour meters located on the Smart Reach Aerial Maintenance Screen.
- The aerial hour meter logs time only when the operator present foot switch is activated.
- Use the aerial hours to determine service intervals.

Lubricants

Recommended Extreme Pressure Lubricants

Following are the lubrication specifications that shall be used on the apparatus. Should other lubricants be used in place of these, or mixed with these; damage to the apparatus is possible. If this occurs, the warranty on specific parts, or the entire apparatus may be VOID.

Table 5-1: Recommended High-Temperature Grease

HIGH TEMPERATURE WHEEL BEARING GREASE		
SUPPLIER	TRADE NAME	NUMBER
Chevron	Dura Lith	EP2
Mobil	Mobilux	EP2
Shell	Alvania	EP2
Texaco	Multifak	EP2
Union	Unoba	EP2

Special Lubrication Recommendations

- The planetary gear swing drive uses an S.A.E. 80/90 wt. All Purpose Gear Lubricant.
- The extension cables use a high quality lubricating oil, such as 30 weight motor oil.

SERVICE PROCEDURES

- The chrome waterway tubes use a light coating of high quality Dextron II.
- Optional ladder retaining tube, bottom chord and section guides use Amsoil X-Treme Synthetic Food Grade Grease.

Table 5-2: Recommended Multi-Purpose Grease

RECOMMENDED MULTI-PURPOSE GREASE	
SUPPLIER	TRADE NAME
Mobil	Mobil Temp
Shell	Darina
Texaco	Thermatex

Lubrication Chart

Following is a numbered lubrication chart. This chart shall be used in conjunction with the 10 hour and 50 hour Lubrication Schedules.

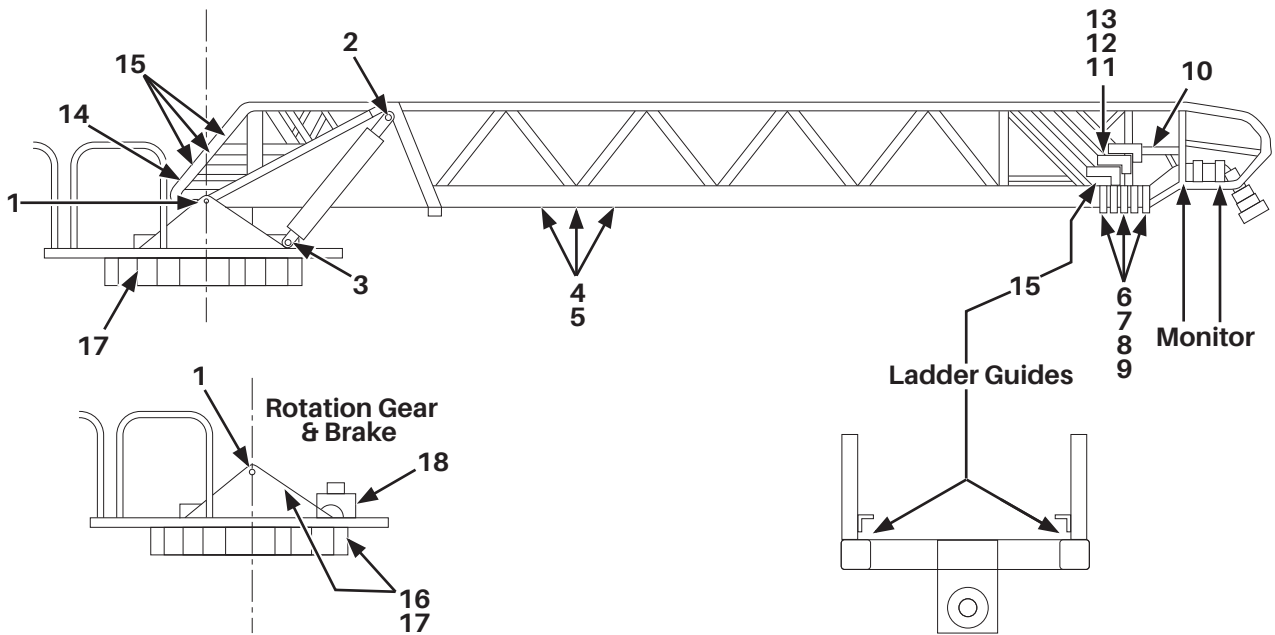

Figure 5-1. Lubrication Chart

LUBRICATION AND PREVENTIVE MAINTENANCE SCHEDULE

The 10 hour and 50 hour lubrication and maintenance schedules should only be performed by a fire apparatus service technician or competent individual appointed by the AHJ who has had proper factory instruction on the maintenance and repair of Spartan Aerial Devices.

NOTICE

For the purposes of this manual, a "Shot" of grease dispensed from a single hand stroke, or a single trigger squeeze of a pneumatic or battery operated grease gun, should produce 0.1 ounce (2-3 grams) of grease. Departments should calibrate the grease guns used to lubricate the aerial device to ensure that the proper amount lubricant is used. Excessive lubrication, as well as inadequate lubrication, can cause excessive wear.

Ten and Fifty Hour Lubrication Schedule

Refer to the Lubrication Chart.

Table 5-3: Lubrication Service Points

Item Number	Description	Lubricant	Lub Intervals
1	Heel Pin x 2	1 shot of EP2	10 Hours
2	Upper Hoist Cylinder Pivot x 2	1 shot of EP2	10 Hours
3	Lower Hoist Cylinder Pivot x 2	1 shot of EP2	10 Hours
4 & 5	Ext. Traveling Blocks & Guides	1 shot of MPG	10 Hours
6, 7, 8 & 9	Waterway Pipe Flanges - 1 zerk each Section	1 shot of MPG	10 Hours
10, 11, 12 & 13	Top retaining tube, bottom of lower cord, required for each ladder section.	Light coating of MPG or Amsoil X-Treme	10 Hours
14	Waterway Elbow	1 shot of MPG	10 Hours
15	All ladder sections guides	Light coating of MPG or Amsoil X-Treme	10 Hours
16	Swing Unit Gear: While rotating, lubricate grease zerk on the turntable while moving turntable 360 degrees.	EP2	50 Hours
17	Rotation Bearing: While rotating, lubricate one grease zerk located on turntable on extension hose while moving turntable 360 degrees in each direction. Only one grease zerk is necessary.	1 shot of EP2	50 Hours
18	Swing Unit: Check oil level.	80/90 Gear Lube	50 Hours
19	All Extension/Retraction cable sheave pin grease zerks, required for each ladder section. Required only if zerks are installed	1 shot of MPG	50 Hours
Chrome Waterway		Dextron 2	
Extension/Retraction Cables		30 Wt. Engine Oil	
Monitor		See Monitor Manufacture Manual	

SERVICE PROCEDURES

Ten-Hour Preventive Maintenance Inspection Schedule

After ten hours of aerial device operation, or quarterly, whichever comes first, perform the following.

1. Check aerial device hydraulic fluid level. Check at the site tube on tank or on the Smart Reach screen, with stabilizers and aerial device stowed.

NOTICE

The aerial ladder should be in the cradle and the stabilizers should be retracted and in the road ready position when checking the hydraulic oil level.

2. Check PTO for proper engagement and operation. (see page 4.8.)
3. Verify the engine high idle speed and operation by activating the button located in the cab, or when activating any stabilizer and ladder control. Engine speed should be 1250 rpm (20.83 Hz) in high idle.
4. Deploy the stabilizers in accordance with the Stabilizing the Apparatus Section of this manual. (see page 4.9.)
5. Check the stabilizer system for proper operation.
 - Extension/retraction travel of the extension beams on outriggers should be smooth.
 - The up/down functions on each jack should be smooth.
 - Check for oil leaks by visually inspecting the stabilizer pads located at the bottom of the jack tube.
 - Check for proper operation of the **Automatic Leveling System**.
 - Extend each stabilizer beam to a different tip load. Verify that the correct load is displayed on the Stabilizer Information Display.
 - Check for proper operation of the stabilizer stowed proximity switches.
 - Verify that all indicators on the stabilizer screen are working properly.
 - Check the stabilizer hydraulic pressure for proper operating pressure while raising the ladder at full speed.
6. Deploy the aerial ladder in accordance with the Ladder Operators Section of this manual. (see page 4.13.)
 - Verify that all ladder controls at the pedestal are working properly.
 - Verify that all indicator lights and gauges are working properly.
 - With a stabilizer extended to 250 or 500, rotate the ladder to that side. Check the stop function. Then continue to rotate in to the lower tip load area and verify that the Smart Reach Aerial Display changes to the correct load.
 - Check the aerial rotation system and swivel. Include checking the swing unit and the swing brake holding ability.

- With the aerial at full extension and at zero degrees or low angle, rotate the ladder to the right and put the rotation control to the neutral position. The ladder should come to a complete stop and hold in that position. Repeat the test rotating the aerial ladder to the left.
 - Check the aerial extension cylinders, cables, and sheaves for proper operation.
 - Check the aerial electrical cables, sheaves, and E-track.
 - Check all aerial ladder section slide pads for proper adjustment.
 - Check the aerial elevation system.
 - Check the operation of all warning lights and audible warning systems.
 - Check the operation of the tracking lights, the tip lights and ladder lights for proper operation.
 - Check the rung alignment indicator.
 - Check all controls at the pedestal, and ladder tip for correct operation.
 - Check the ladder hydraulic pressure for proper operating pressure while raising the ladder at full speed.
 - Inspect the rung covers and clips on the ladder sections. They must be secure and shall not be able to turn on the rungs. They must be free of cuts or rips.
 - Operate the Positional Waterway and inspect locking mechanism and that latches engage properly in both positions
7. Extend the ladder fully over the side or rear of the apparatus, lowering the tip a few feet from the ground.
 8. Lubricate the aerial device. Refer to Lubrication Schedule and Lubrication Chart. ([see page 5.4.](#))
 9. Check waterway piping system for proper alignment and lubrication.
 - Inspect all water pipes for proper alignment, attachment and lubrication.
 - With the aerial device fully extended near the ground, clean the waterway with mild hand soap.
 - Coat the waterway pipes with a very light coating of Dextron II or equivalent non-corrosive oil.
 - Check the water system monitor from all control positions for proper operation; up, down, right, left, shape, and stream.
 - The rotation points of the monitor should be lubricated as per the manufacturer of the monitor.
 10. Check all aerial interlock systems that apply to your apparatus. ([see page 4.26.](#))
 - Jacks not in contact with the ground, aerial lock out - With one or more stabilizer jacks not in contact with the ground, attempt to raise the ladder from the cradle. The interlock should prevent the aerial from being raised.
 - Stabilizer lock out when ladder is out of the cradle - With the ladder out of the cradle about 10 degrees, have a 2nd operator. Attempt to raise one of the stabilizer jacks. The interlock should prevent the jack from being raised.

SERVICE PROCEDURES

- Short Set Rotation Interlock – Short set one side of the stabilizer system. Raise the ladder from the cradle and rotate to the short set side. Rotation must stop as indicated on the Multi-Stance™ Load Chart Screen. Stop rotation if the ladder goes beyond the indication.
 - Body/Cab Collision Avoidance – With spotters in position, move the ladder vertically and horizontally toward the body or cab. The ladder movement should stop when 12 in. (304.8 mm) or more from the body or cab. Stop movement if the ladder is less than this distance.
 - Automatic Aerial Stowing – With a spotter in position, move the aerial over the cab. Activate Automatic Aerial Stowing, aerial should cradle itself. If the aerial is not aligned with the cradle, release the Automatic Aerial Stowing button.
 - Extended Range Monitor (If equipped) – In Water Tower mode move the monitor into the extended range. Change the monitor to Rescue Mode. The monitor should automatically move out of the extended range.
 - Monitor Stow (If equipped) – Move the monitor out of the stowed position. Activate the auto stow.
11. Check the breathing air system and its components (if provided) for proper operation. (see page 4.24.)
- Open the tank valve(s).
 - Check the pressure in the storage tank(s).
 - Pressurize the system and check of any leaks. (Do not use hands or any part of the body to check for leaks)
 - Attach a respiratory device and check for air flow.
 - Check the breathing air pressure indicator on the Smart Reach Display.
 - When complete, shut off the tank valves and release pressure from the system or leave system as per your departments SOP.
12. Check the intercom system at the turntable and at the tip of the fly section. If there is a pump-mounted speaker, it should be inspected for operation as well.
13. Check the emergency power unit for proper operation. (see page 4.29.)

Fifty-Hour Lubrication Schedule

Refer to the Lubrication Chart on [page 5.4](#). Perform the 10 hour and 50 hours lubrications.

Fifty-Hour Preventive Maintenance, Inspection, & Testing Schedule

After fifty hours of aerial device operation, or annually, whichever comes first, in addition to the ten hour lubrication and preventive maintenance schedule, perform the following.

For departments that have a third-party inspection/testing conducted on the aerial device annually, verify with your testing company which of the following items are covered in their inspection. The department will need to make certain that any item not inspected by the 3rd party is inspected.

Refer to the Spartan Motors USA, Inc. Maintenance & Repair and Parts Manuals for details of these components and instructions on making adjustments or repairs.

In addition to the 10 - hour preventive maintenance inspection schedule, inspect the following.

1. Inspect PTO and hydraulic pump installation.
 - The PTO and the hydraulic pump should show no signs of external leakage or excess vibration, which would indicate a possible problem with the installation.
2. Check stabilizers for;
 - Proper alignment.
 - Inspect hoses for leaks or wear on the hoses in the beam.
 - Inspect jack tube pins for proper alignment.
 - Check all snap rings, retaining bolts and pins.
 - Conduct drift test on cylinders.
3. Inspect the hydraulic, electrical and waterway swivel.
 - Check the assembly for a secure mounting.
 - Check for oil leaks, water leaks and loose electrical connections.
4. Inspect the aerial pivot assembly and pivot pins, as well as all retaining bolts at the turntable for wear, security and lubrication.
5. Inspect the elevation cylinders;
 - Proper mountings and rigging.
 - Hoses and tubing wear/secure mounting and leaks.
 - Inspect mounting pins at both the rod and barrel ends for secure mounting.
 - Inspect snap rings and/or bolts, which keep mounting pins in place for security.
 - Conduct drift test on cylinders.
6. Inspect the extension/retraction cylinders including;
 - Proper mountings and rigging.
 - Hoses and tubing wear/secure mounting and leaks.
 - Inspect mounting pins at both the rod and barrel ends for secure mounting.
 - Inspect snap rings and/or bolts, which keep mounting pins in place for security.
7. Check for proper adjustment of extension/retraction cables.

NOTICE

The ladder must be adequately lubricated before any cable adjustments are made. To check cable tension on ladders with water pipes;

SERVICE PROCEDURES

- Fully extend the ladder.
 - Raise the ladder to sixty degrees elevation.
 - Fully retract the ladder.
 - Lower the ladder to zero degrees elevation.
 - There should be a 1/2 in. (12.7 mm) to 1 in. (25.4 mm) gap between the front of the base section front cross member and the back of the lower mid section water pipe flange mounting bracket. This gap should be maintained for all the ladder sections and should not be any larger or smaller than recommended.
8. Inspect the following wear pads and thrust blocks. A 1/32 In. (0.79375 mm) to 1/16 In. (1.5875 mm) gap is required between slide pad and ladder components, checked when ladder is fully retracted.
- Base section wear pads and side thrust blocks.
 - Lower-mid section wear pads, slide blocks and side thrust blocks.
 - Upper-mid section wear pads, slide blocks and side thrust blocks.
 - Lower fly section wear pads, slide blocks and side thrust blocks for five section ladders.
 - Fly section slide blocks.
9. Inspect the water system pipes for proper alignment, attachment, lubrication and scoring.
10. Inspect the water system monitor for proper alignment. Check for water leaks, secure mounting and for excess wear in the gears that activate the monitor.
11. Inspect the turntable bearing for;
- Excessive gear wear or chipped teeth.
 - Grease on the turntable bearing and pinion gear. The bearing should be turned through two full revolutions while greasing through any one fitting. (It is preferable to rotate the bearing while greasing in order to uniformly distribute the lubricant and effectively flush out the old lubricant and contaminants.)

NOTICE

If the old grease is in good condition and free of contaminants, the interval may be extended. Conversely, if the old lubricant is contaminated or deteriorated, the interval should be shortened, or the old grease removed and replaced.

12. Inspect the swing pinion gear for excess wear or chipped teeth.
- Check lubricant level in the swing unit.
 - Lubricate gears as needed while rotating the ladder.
 - Remove the plug from the swing drive, as long as oil is visible the unit has ample lubrication.
 - Grease the swing unit.

13. Check the torque on the turntable bearing mounting bolts (both upper and lower) and pinion gear mounting bolts.
14. Replace the return oil filter located on the oil tank and pressure filter cartridge.
15. Check the torque on the frame mounting bolts. The frame mounting bolts may either be 1/2 in. or 5/8 in. depending on the chassis. The 5/8 in. (15.875 mm) bolts should be torqued to 175 ft/lbs (237 Nm). The 1/2 in. (12.7 mm) bolts should be torqued to 80 ft/lbs (109 Nm).
16. Inspect the cradle for mounting security and cracks in the welds or structure.
17. Inspect the torque box for cracks in the welds or structure.
18. Inspect the aerial ladder structure and its components for cracks in the welds or structure.
19. Visually inspect all torque box to frame mounting plates for cracks, fractured welds, and damage.

NON-DESTRUCTIVE TESTING

Non-destructive testing of the aerial device shall be conducted for any of the following conditions.

1. Every 5 years or 300 hours, whichever comes first.
2. If visual inspection or load testing indicates a potential structural or safety problem.
3. If there is a desire to further confirm continued operational safety.
4. After any major repairs or overhaul to the aerial structure or systems.
5. Aerial has been subjected to unusual operating conditions of stress or loading.
6. When there is reason to believe that usage has exceeded the manufacture's recommended aerial device operating parameters.

The requirements of the NFPA 1911 *Standard for the Inspection, Maintenance, Testing and Retirement of In-Service Automotive Fire Apparatus*, latest edition shall be referenced. Any Federal, State, Provincial or Local regulations or standards that are applicable shall also apply.

SERVICE PROCEDURES

THESE PROCEDURES SHALL ALL BE REPEATED ON A CYCLIC BASIS, AS LONG AS THE AERIAL IS IN SERVICE. THE DEPARTMENT IS RESPONSIBLE FOR ENSURING PROCEDURES HAVE BEEN FOLLOWED!

SAMPLE AERIAL LADDER PREVENTIVE MAINTENANCE CHECK LIST

Daily/Weekly Inspections

Department Name: _____									
Address: _____									
City: _____	State/Province: _____			Postal or Zip Code: _____					
Department Apparatus #: _____				Chassis Type: _____					
Vin: _____				Aerial Model: _____					

Inspection Description	Frequency	Daily	Daily	Daily	Daily	Daily	Daily	Daily	Weekly	
Daily Checks										
Inspect for hydraulic leaks.										
Inspect the aerial platform and turntable for;										
Loose or missing equipment.										
Damage to the ladder structure.										
Foreign objects in the ladder structure.										
Loose or missing hardware, nuts, bolts, pins, ETC.										
Cracks in the ladder structure.										
Check hydraulic fluid level.										
Aerial device controls access doors are secure.										
Mounted equipment is secured.										
Ladder and stabilizers are properly stowed.										
Positional waterway mechanism is in the correct position.										
Access ladder(s), pull out platforms, & fold down steps are stowed properly.										
Auxiliary pads and wheel chocks are not damaged and stowed properly.										
Weekly Aerial Operation Inspection										
Aerial Power and PTO switches engage.										
Inspect auxiliary pads for damage.										
All outriggers extend and retract properly. No unusual noises.										
Jack extend and retract properly.										
Inspect stabilizer system for leaks.										
Stabilizer warning lights illuminated.										
Raise ladder out of cradle, checking system pressure gauge for proper reading.										
Ladder elevates, rotates, extends/retracts properly.										
Inspect the ladder for hydraulic leaks.										

Inspection Description	Frequency	Daily	Daily	Daily	Daily	Daily	Daily	Weekly	
	Date:								
Rung Alignment indicator.									
Aerial Communication System operates properly from all positions.									
Positional waterway mechanism functions properly.									
Monitor elevates, sweeps and nozzle pattern adjusts properly.									
Ladder Tip Controls operate properly.									
All ladder low voltage lights illuminate.									

AERIAL ANNUAL INSPECTION CRITERIA

NFPA 1911 Standard for the Inspection, Maintenance, Testing, and Retirement of In-Service Emergency Vehicles requires an annual inspection. This section provides the manufacturers recommendations for the required inspections and tests.

Rotation Bearing Mounting Bolts

Measure the torque on the Rotation Bearing and Gear Box bolts in accordance with the following chart:

Table 5-4: Rotation Bearing Mounting Bolts

Aerial Device	Location	Bolt Size (in.)	Bolt Grade	Torque (ft-lbs)
57 ft. (17 m) Rear Mount Ladder - 2 Section	Upper Rotation Bearing	.500	8	80-90
	Lower Rotation Bearing	.625	8	170-180
	Rotation Gear Box	.625	5	100-110
77 ft. (23 m) Rear Mount Ladder - 3 Section	Upper Rotation Bearing	.625	8	170-180
	Lower Rotation Bearing	.625	8	170-180
	Rotation Gear Box	.625	5	100-110
102 ft. (31 m) Rear Mount Ladder - 4 Section 107 ft. (33 m) Rear Mount Ladder - 4 Section	Upper Rotation Bearing	.625	8	170-180
	Lower Rotation Bearing	.625	8	170-180
	Rotation Gear Box	.750	5	150-160
127 ft. (39 m) Rear Mount Ladder - 4 Section	Upper Rotation Bearing	.875	8	440-450
	Lower Rotation Bearing	.875	8	440-450
	Rotation Gear Box	1.00	5	390-400

Rotation Gear Backlash

Measure the rotation gear backlash by setting up the aerial apparatus and completely extending the device. Push on the tip of the device by hand in one direction and make a mark at the edge of the turntable platform to indicate the ladder location relative to the platform. Push on the tip of the device in the opposite direction and make another mark on the edge of the turntable platform. The space between the marks should not exceed the appropriate value in the table:

SERVICE PROCEDURES

Rotation Bearing Clearance

Measure the rotation bearing clearance by mounting a dial indicator or other accurate measuring device so that it is measuring the position of the inner bearing race with respect to the outer bearing race. Measure the position with the device resting in the cradle, and then again with the ladder out of the cradle. The difference between these measurements should not exceed the value in the table.













Table 5-5: Rotation Bearing Clearance

Aerial Device	Measurement	Motion	
		(in.)	(mm)
57 ft. (17 m) Rear Mount Ladder - 2 Section	Gear Backlash	1.00	25
	Bearing Clearance	.065	1.65
77 ft. (23 m) Rear Mount Ladder - 3 Section	Gear Backlash	.054	1.37
	Bearing Clearance	.064	1.63
102 ft. (31 m) Rear Mount Ladder - 4 Section 107 ft. (33 m) Rear Mount Ladder - 4 Section	Gear Backlash	1.00	25
	Bearing Clearance	.082	2.01
127 ft. (39 m) Rear Mount Ladder - 4 Section	Gear Backlash	1.50	38
	Bearing Clearance	.100	2.54

Structural Fasteners

The following fastener torque chart applies to all fasteners on the Aerial Device unless otherwise specified.

Table 5-6: Structural Fasteners

FINE OR COARSE THREAD FASTENER	GRADE DESIGNATION	TENSILE STRENGTH MINIMUM	MATERIAL	3/8	7/16	1/2	9/16	5/8	3/4	7/8	1	1-1/4	1-1/2
				TORQUE FOOT/POUNDS (MIN-MAX.)									
 CAP SCREW	S.A.E. 2 A.S.T.M. A-307 STEEL	64,000 P.S.I.	Low Carbon Steel	17	26	41	56	83	140	182	270	449	718
				19	30	45	66	93	150	202	300	500	797
 CAP SCREW	S.A.E. 3 STEEL	100,000 P.S.I.	Medium Carbon Steel	26	43	59	93	135	214	332	491	822	1327
				30	47	69	103	145	234	372	551	922	1471
 CAP SCREW	A.S.T.M. A-449 S.A.E. 5 STEEL	105,000 P.S.I.	Medium Carbon Steel or Low Alloy Heat Treated	27	46	65	100	140	220	338	523	747	1194
 CAP SCREW	A.S.T.M. 354BB STEEL			31	50	75	110	150	250	378	583	833	1323
 CAP SCREW	A.S.T.M. A-325			-	-	90	-	180	305	465	710	1019	1771
 CAP SCREW	A.S.T.M. A- 354-BC STEEL	125,000 P.S.I.	Low Alloy or Med. Carb. Quenched Tempered	30	50	71	109	147	239	377	574	1024	1522
				34	54	81	119	167	269	427	644	1053	1695
 CAP SCREW	S.A.E. 6 STEEL	133,000 P.S.I.	Med. Carbon Steel Quenched Tempered	39	59	96	140	189	310	490	735	1242	1989
 CAP SCREW	S.A.E. 7 STEEL		Med. Carbon Alloy, Quenched Tempered Roll Threaded	43	69	106	150	209	350	550	825	1372	2205
 CAP SCREW	S.A.E. 8 STEEL	150,000 P.S.I.	Med. Carbon Alloy Quenched Tempered	42	65	105	145	185	330	531	803	1331	2153
				46	75	115	165	225	370	591	893	1486	2383
 SOCKET CAP SCREW	SOCKET HEAD CAP SCREW ALSO N.A.S. AIRCRAFT STD.	160,000 P.S.I.	High Carbon Alloy Quenched Tempered	46	71	111	156	210	345	569	864	1804	2947
 CAP SCREW	N.A.S. 144 AIRCRAFT STD. MS 20000 MIL. STD.			50	81	121	176	240	395	629	964	1964	3147
 CAP SCREW	N.A.S. 624 NATIONAL AIRCRAFT STANDARD STEEL	180,000 P.S.I.	High Carbon Alloy Quenched Tempered	52	81	126	188	255	419	668	1025	2105	3355
				56	91	136	198	270	444	708	1085	2255	3855

SERVICE PROCEDURES

Relief Hydraulic Pressure

The correct hydraulic system pressure is indicated on the Hydraulic Screen which can be accessed on the Smart Reach Aerial Display or on the Stabilizer Information Display.

Hydraulic Cylinder Allowable Drift

Measure the hydraulic cylinder drift in accordance with the instructions in NFPA 1911. Drift in one hour with the engine off should not exceed the values in the following chart:

Table 5-7: Hydraulic Cylinder Allowable Drift

Component	Allowable Drift	
	(inch)	(millimeters)
Stabilizer Cylinder	.375	10
Aerial Lift Cylinders	.500	13
Aerial Extension Cylinders	.500	13

Aerial Device Deployment

Your aerial device should be able to deploy within a reasonable amount of time, but not so quickly that it cannot be controllable or that it would create discomfort for people on the device. Measure the speed of operation and deployment. Operate your device for this test in the fast idle mode. Times should fall within the values on the following chart.

Table 5-8: Aerial Device Deployment

Operation	Test Description
Stabilizer deployment	Measure one stabilizer at a time. Begin with stabilizer stowed and end with the stabilizer fully extended and the jack on the ground.
Aerial Device Elevation	Begin with device retracted and in the cradle. Keep the device retracted for this test. Measure the time to raise the device to full elevation.
Aerial Device Depression	Begin with device retracted and at full elevation. Keep the device retracted for this test. Measure the time to lower the device to 0 degrees elevation.
Aerial Device Rotation	Place the device in a position where it can be rotated 360 degrees without the need to elevate, depress, extend or retract. Measure the time to make one complete revolution.
Aerial Device Extension	Position the device at 0 degree elevation and fully retracted. Measure the time to fully extend the device.
Aerial Device Retraction	Position the device at 0 degree elevation and fully extended. Measure the time to fully retract the device.

Table 5-9: Performance Values

Aerial Device	Elevation or Depression (sec)		Rotation (sec)		Extension or Retraction (sec)	
	Min	Max	Min	Max	Min	Max
57 ft. (17 m) Rear Mount Ladder - 2 Section	30	60	100	130	30	60
77 ft. (23 m) Rear Mount Ladder - 3 Section	30	60	100	130	30	60
102 ft. (31 m) Rear Mount Ladder - 4 Section 107 ft. (33 m) Rear Mount Ladder - 4 Section	35	65	120	150	35	65

Aerial Device	Elevation or Depression (sec)		Rotation (sec)		Extension or Retraction (sec)	
	Min	Max	Min	Max	Min	Max
127 ft. (39 m) Rear Mount Ladder - 4 Section	55	85	150	180	55	85

Ladder Section Alignment

While your aerial device should be reasonably straight, the design does expect that some amount of twist is acceptable. Use either Method A or Method B to measure twist:

Method A

- Position your apparatus on a perfectly level surface that remains flat and level for the length of the aerial when extended.
- Extend the device completely at a zero degree elevation.
- Measure from each rung rail to the ground and determine the difference between measurements.
- The ladder at the end of the fly section should not show more than 1 in. (25.4 mm) of difference between these measurements.

Method B

- Position your apparatus.
- Extend the device completely at a zero degree elevation.
- Place a straight edge across the base section rung rails as near the base of the ladder as practicable.
- Measure the angle of the straight edge with an inclinometer with an accuracy of +/- 0.1 degrees.
- Place a straight edge across the fly section rung rails as near the end of the ladder as practicable.
- Measure the angle of the straight edge with an inclinometer with an accuracy of +/- 0.1 degrees.
- The difference between these measurements should not exceed 2.5 degrees.

Slide Pad Wear

Slide pad wear is expected due to the rigors of operation. The amount of wear will depend on the lubrication frequency and the cleanliness of the lubricant. Lubricant that becomes contaminated with dirt, sand, or other gritty materials will accelerate slide pad wear. Slide pads should be replaced when wear exceed 25% of their original thickness.

Hydraulic Cylinder Leakage







Place the equipment into a position where the cylinder is half way between fully extended and fully retracted. Wipe the seal and the rod thoroughly clean. Leave the apparatus sit for one hour with the hydraulic system off. No leaking or weeping should be observable on the rod at the sealing interface.







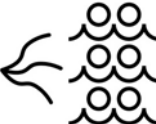
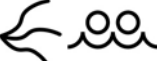

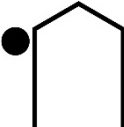
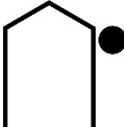
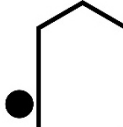
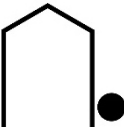

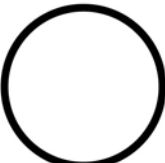





For future use

APPENDIX

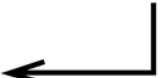

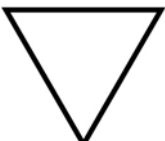



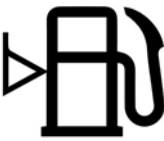





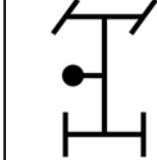
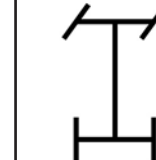
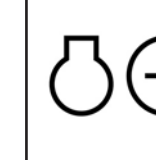
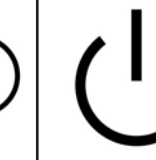









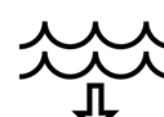











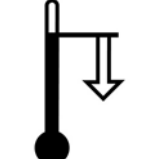

Graphical Symbol Definitions





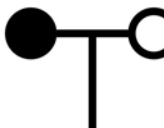



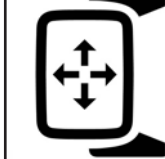
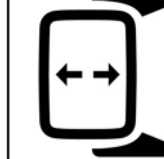





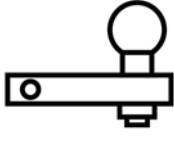





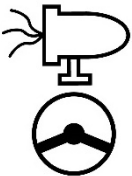



Your apparatus may use graphical symbols to indicate the function of switches, controls, gauges, or components. Study this section so you will understand the meanings of these symbols. For more in-depth explanations of the symbols you can refer to *TC008 Graphical Symbols for Automotive Fire Apparatus* available for download at FAMA.org.

Base Symbols						
						
Water	Foam Concentrate	Foam Solution	Powder	Compressed Air Foam (CAF) Wet	Compressed Air Foam (CAF) Dry	Halotron
						
Location Left Front Cab or Apparatus	Location Right Front Cab or Apparatus	Location Left Rear Cab or Apparatus	Location Right Rear Cab or Apparatus			

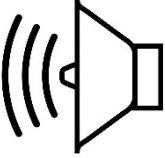

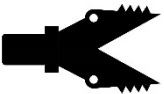
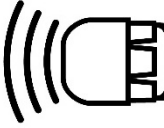

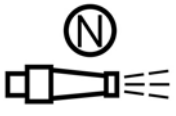
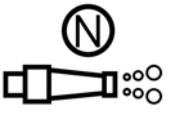
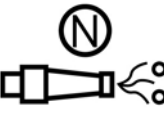
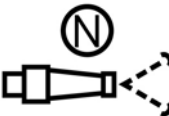
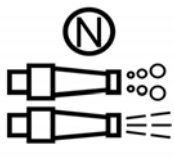
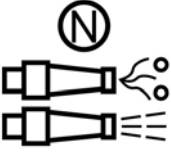
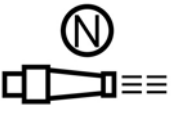
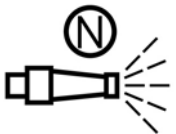
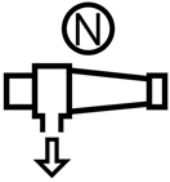
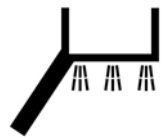

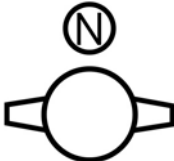
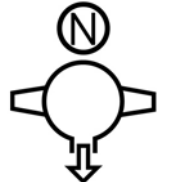
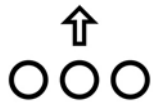







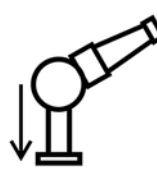
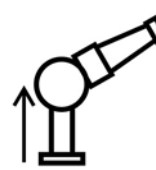

General Symbols						
						
On / Start	Off / Stop	On and Off	Clock / Time Switch / Timer	Fast	Slow	Continuously Variable-Linear
				AUTO		
Continuously Variable-Rotational	Unlock or Switch Interlock	Bell or Alarm	Manual Operation / Manual Start	Auto Operation / Automatic Start	Back	Select
						
Up	Down	Warning	Engine Rotational Speed	Engine Rotational Speed-Instantaneous Decrease	Engine Coolant	Fuel Level

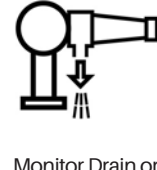

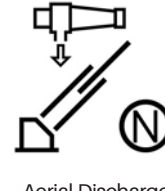

APPENDIX

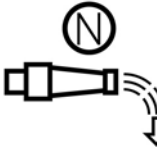
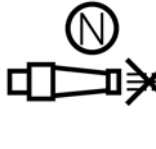

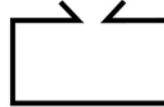

General Symbols						
						
Emergency Stop	Power Take-Off (PTO)	Power Take-Off Engage	Road Mode	Engine Operating Hours	Standby	Breathing Air (SCBA)
						
Siren Mechanical	Horn	Air Horn	Foam Pressure	Hydraulic Pressure	Hydraulic Pump	Air Compressor
						
Radiator Re-Fill	Emergency Power Unit	Water Flush	Air Purge or Drain	Ladder Rack Down	Ladder Rack Up	Compartment Door Alert
						
Pumper Apparatus	Aerial Ladder Apparatus	Suspension Front	Suspension Rear	Helmet Restraint	Compartment Door	Equipment Restraint
						
Auxiliary Cooler	Height of Vehicle Hint for Driver	Width of Vehicle Hint for Driver	GVWR of Vehicle Hint for Driver	Fording Depth Water Crossing Ability	Fording Depth Water Crossing Hint for Driver	Video Camera
						
Rear View Video Camera	Wind Speed	Compartment Door Open	Apparatus Front View	Aerial Apparatus Front View	Exterior Rear View Mirror 4-Way Adjustment	Exterior Rear View Mirror 2-Way Adjustment

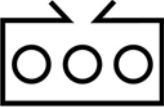

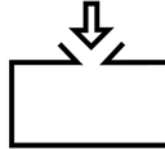
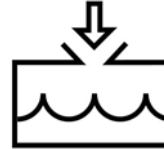
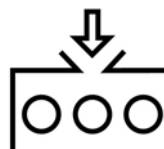
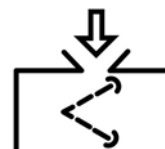
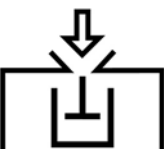
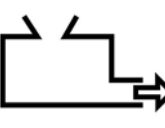
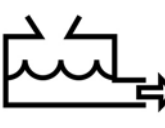
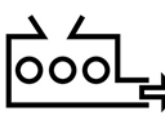
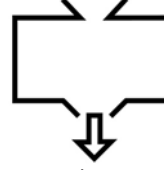

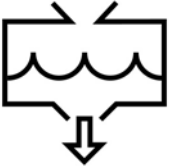
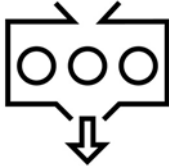
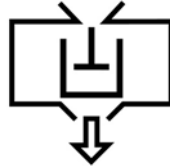

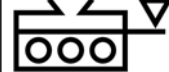

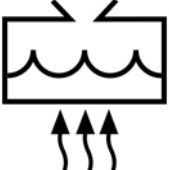
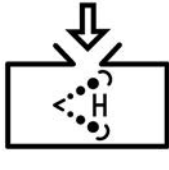
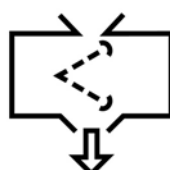











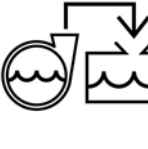
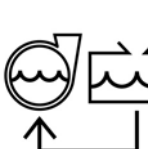

General Symbols						
						
Exterior Rear View Mirror Heat	Engine Cooling Fan Clutch Lock	Traffic Signal Preemption OFF	Engine Emergency Shut-Down	Ball Hitch or Ball Hitch Receiver	Tanker or Tender	Brush Truck or Mini-Pumper
						
Wildland Apparatus	Digital Alert Warning System	Siren Brake	Automatic Tire Chain	Siren Operated by Steering Wheel Center Switch	Air Horn Operated by Steering Wheel Center Switch	Generator PTO Engage
						
Air Compressor PTO Engage	Transmission Retarder or Brake	Engine Compression or Exhaust Brake	Neutral	Cab Heat	Electronic Siren	Electronic Siren Activated through Steering Wheel Horn Button
						
Front Axle Brake Lock	Extrication Tools	Low Frequency Electronic Siren (Rumbler)	AM/FM Radio, Stereo, etc...			
Discharge & Intake						
						
Water Discharge	Foam Discharge	CAF Discharge	Powder Discharge	Foam or Water Discharge	CAFS or Water Discharge	Stream
						
Fog	Discharge Drain or Bleeder	Aerial Platform Water Curtain	Pavement Cooler Discharge	Intake	Intake Drain or Bleeder	Foam Intake

APPENDIX

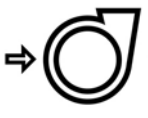
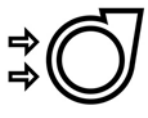

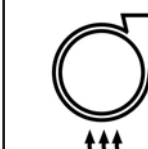

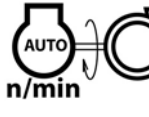
Discharge & Intake						
 Remote Monitor	 Manual Monitor	 Monitor Elevate	 Monitor Depress	 Monitor Lower	 Monitor Raise	 Monitor Rotate CCW
 Monitor Rotate CW	 Monitor Oscillate	 Monitor Stow	 Monitor Drain or Bleed	 Aerial Water Discharge	 Aerial Foam Discharge	 Aerial CAF Discharge
 Aerial Powder Discharge	 Aerial Discharge Drain	 Aerial Intake	 Shower Discharge	 Nozzle Flush	 Nozzle Off	 Water Flow Rate
 Water Flow Total						

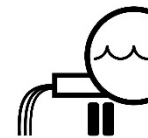
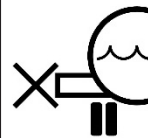
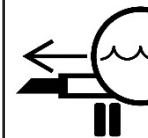

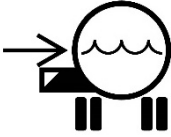
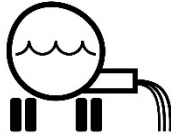
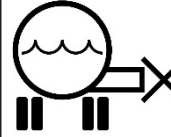
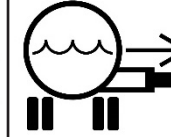
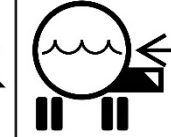

Tank						
 Tank	 Water Tank	 Foam Tank	 Powder Tank	 Hydraulic Tank	 Tank Fill	 Water Tank Fill
 Foam Tank Fill	 Powder Tank Fill	 Hydraulic Tank Fill	 Tank Outlet	 Water Tank Outlet	 Foam Tank Outlet	 Tank Drain

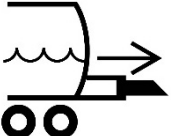
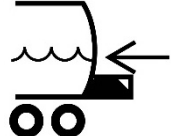



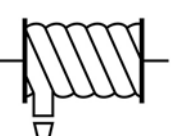
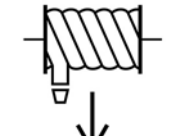

Tank						
						
Water Tank Drain	Foam Tank Drain	Hydraulic Tank Drain	Tank Level	Water Tank Level	Foam Tank Level	Hydraulic Tank Level
						
Water Tank Heater	Halotron Tank Fill	Powder Tank Drain				

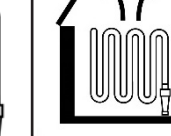
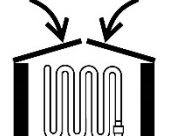
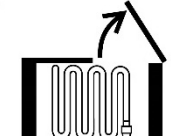
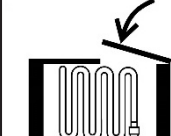
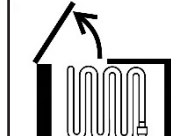
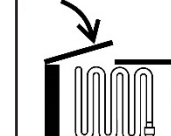

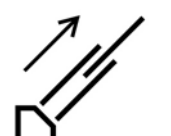
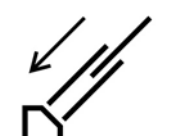
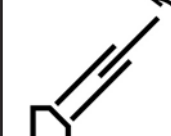
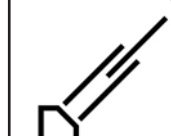

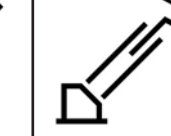
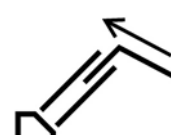
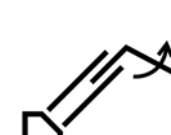
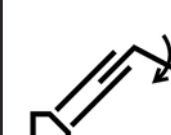

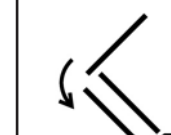

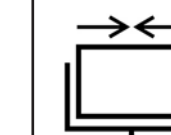

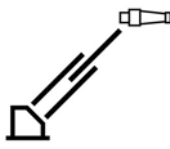
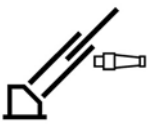
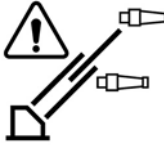
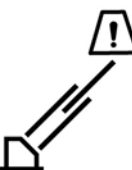

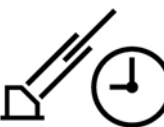

Fire Suppression Pump Functions & Features						
						
Pump	Pump Engage	Pump Engage Manually	Water Pump Engage	Foam Pump Engage	Pump Intake	Pump Discharge
						
Pump Priming	Pump Priming	Pump Drain	Pump-to-Tank Valve	Tank-to-Pump Valve	Pump Cooling Recirculation Valve	Pump Water Temperature
						
Pump Transmission Temperature	Water Pump Discharge Relief	Foam Pump Discharge Relief	Pump Low Pressure	Pump High Pressure	Pump Ultra High Pressure	Pump Heater
						
Pump Compartment Heater	Pump Hour	Pump Pressure Governor	OK to Pump	Dump Chute Left OPEN	Dump Chute Left CLOSE	Dump Chute Left EXTEND



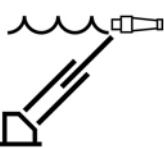







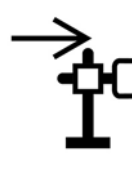

APPENDIX

Fire Suppression Pump Functions & Features						
 Dump Chute Left RETRACT	 Dump Chute Right OPEN	 Dump Chute Right CLOSE	 Dump Chute Right EXTEND	 Dump Chute Right RETRACT	 Dump Chute Rear OPEN	 Dump Chute Rear CLOSE
 Dump Chute Rear EXTEND	 Dump Chute Rear RETRACT	 Foam Pump	 Foam Pump OFF			

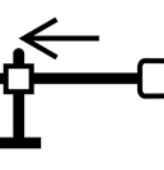
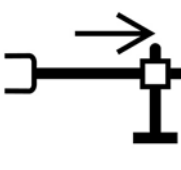
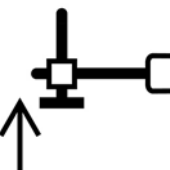
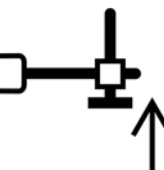
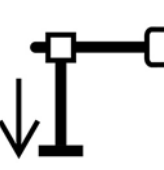
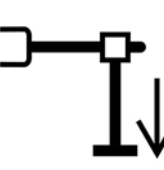





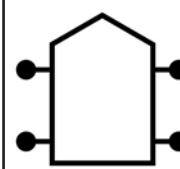
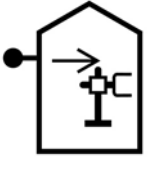
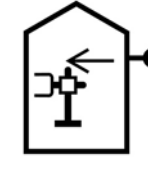
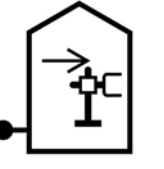

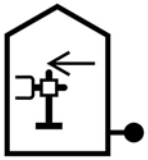
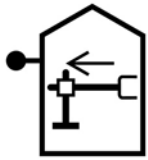
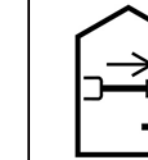
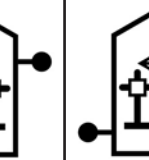
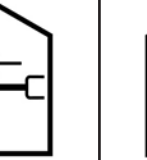
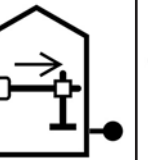
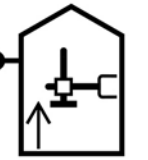
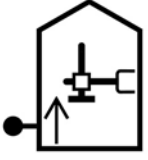
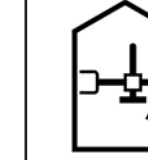
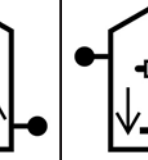

Hose						
 Hose Reel	 Hose Reel Wind Out	 Hose Reel Wind In	 Pre-connected Hose	 Hose	 Hose Restraint	 Hose Bed Cover OPEN
 Hose Bed Cover CLOSE	 Hose Bed Cover RH OPEN	 Hose Bed Cover RH CLOSE	 Hose Bed Cover LH OPEN	 Hose Bed Cover LH CLOSE		

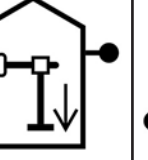
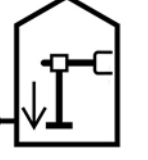
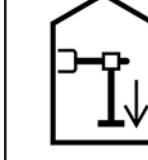

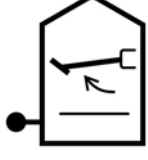
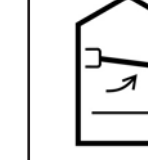
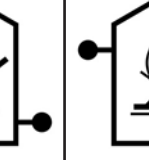
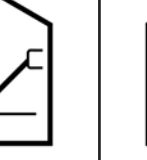
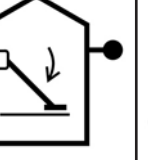

Aerial Device						
 Aerial Extend	 Aerial Retract	 Aerial Elevate	 Aerial Depress	 Aerial Rotate CCW	 Aerial Rotate CW	 Aerial Articulate Extend
 Aerial Articulate Retract	 Aerial Articulate Elevate	 Aerial Articulate Depress	 Aerial Boom Raise	 Aerial Boom Lower	 Ladder Rungs Aligned	 Aligned with Cradle





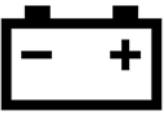

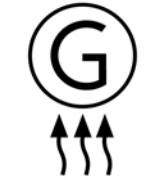

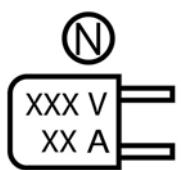
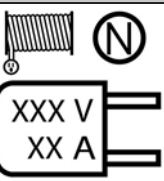
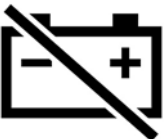
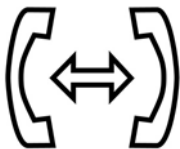































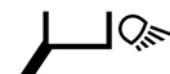

Aerial Device						
						
Automatic Aerial Stowing	Aerial Monitor Water Tower Mode	Aerial Monitor Rescue Mode	Movable Monitor Not Secure	Aerial Overload	Aerial Platform Overload	Aerial Platform Leveling
						
Aerial Platform Rotate CCW	Aerial Platform Rotate CW	Aerial Hours	Aerial Power	Aerial Device Enable	Tip Controls Enable	Aerial Waterway Wet
						
Aerial Nozzle Nozzle Angle Up	Aerial Body Collision Alert	Aerial Body Collision OFF	Aerial Device Not Stowed	Stabilizer Not Stowed	Trailer Jackknife Warning	

Stabilizers						
						
Left Stabilizer Up	Right Stabilizer Up	Left Stabilizer Down	Right Stabilizer Down	Left Beam In	Right Beam In	Left Beam Out
						
Right Beam Out	Left Jack Up	Right Jack Up	Left Jack Down	Right Jack Down	Stabilizer Off-Level Warning	Stabilizers Automatic Leveling
						
Stabilizers Manual Leveling	Stabilizers Short-Jack Warning	Stabilizers Set	Stabilizers Locations	Front Left Beam In	Front Right Beam In	Rear Left Beam In

APPENDIX

Stabilizers						
						
Right Rear Beam In	Front Left Beam Out	Front Right Beam Out	Rear Left Beam Out	Rear Right Beam Out	Front Left Jack Up	Front Right Jack Up
						
Rear Left Jack Up	Rear Right Jack Up	Front Left Jack Down	Front Right Jack Down	Rear Left Jack Down	Rear Right Jack Down	Front Left Stabilizer Up
						
Front Right Stabilizer Up	Rear Left Stabilizer Up	Rear Right Stabilizer Up	Front Left Stabilizer Down	Front Right Stabilizer Down	Rear Left Stabilizer Down	Rear Right Stabilizer Down
						
Left Stabilizer Extend Inclined	Right Stabilizer Extend Inclined	Left Stabilizer Retract Inclined	Right Stabilizer Retract Inclined			

Electrical						
						
Battery	Ammeter	Generator	Generator Pre-Heater	Voltmeter	Electrical Outlet	Electrical Cord Reel Outlet
						
Battery Disconnect	Intercom					

Lighting						
						
Panel Light	Dome Light	Flood Light	Adjustable Work Light	Reading Light	Engine Compartment Light	Pump Compartment Light
						
Hose Bed Light	Front Scene Light	Rear Scene Light	Left Side Scene Light	Right Side Scene Light	Perimeter Ground Lights	Elevating Light
						
Elevating Light Raise	Elevating Light Lower	Elevating Light Elevate	Elevating Light Depress	Elevating Light Rotate CCW	Elevating Light Rotate CW	Elevating Light Stow
						
Aerial Base Light	Aerial Tip Light	Aerial Ladder Climbing Light	Day Night Switch	Low Level Interior Illumination	Aerial Tip Light Line Voltage	Aerial Tip Light Low Voltage
						
Blocking Mode Night	Platform Bucket Bottom Lights	Platform Bucket Front Lights	Platform Bucket Side Lights	Emergency Master Lighting	Elevating Light Behind Cab Left Side	Elevating Light Behind Cab Right Side
						
Elevating Light Rear Body Left Side	Elevating Light Rear Body Right Side	Warning Light-Front	Warning Light-Side	Warning Light-Rear	Scene Light-Front	Scene Light-Rear

APPENDIX

Lighting						
Alley Light Left Side	Alley Light Right Side	Scene Light Left Side	Scene Light Left Front	Scene Light Left Rear	Scene Light Right Side	Scene Light Right Front
Scene Light Left Rear	Headlamp Wig-Wag	Warning Light Mechanical Spinning	White Warning Lights OFF	Warning Light Single Front	Compartment Light	Light Bar
Brow Light Narrow Beam	Brow Light Wide Beam	Headlights Flashing	Docking Lights	Command Light Green	White Warning Lights	Brow Light Spot Beam

Foam & CAFS						
Foam Concentrate Injection	Foam Concentrate Injection Rating by Percent	Foam Concentrate Injection ON	Foam Concentrate Injection OFF	Foam Concentrate Injection ON-OFF	Foam Concentrate and Air Injection	Foam Concentrate and Air Injection ON
Foam Concentrate and Air Injection OFF	Foam Concentrate and Air Injection ON-OFF					



REVGROUP

CAT. RML-SR-057-127-2304